



ZÁKLADNÝ CENNÍK 2026

Platný od 4.3.2026



BTR SYSTEMS	3 - 9
Modulová krytina	10 - 19
Krytina na mieru	20 - 29
Trapézová krytina	30 - 34
Strešné panely	35 - 41
Odkvapový systém	42 - 54
Strešné doplky	55 - 65
Plotový systém	66 - 69
Oplechovanie komína	70 - 73
Príplatky	74



Inovácia. Najvyššia kvalita výrobkov. Vytváranie nových úžitkových vzorov. Sú to aj hodnoty, ktoré už roky vyznačujú rytmus každodennej práce našich odborníkov. Ako líder vo výrobe strešných krytín a fasády v Poľsku, spoločnosť už s 50-timi rokmi skúseností, garantujeme najvyššiu starostlivosť pri výrobných procesoch. Zabezpečujeme, aby naša práca bola perfektná v každej fáze, od dizajnu cez výber materiálov a farieb, výrobu až po samotnú montáž.

Strešný krytina BlachotrapezU sú presné v každom detaile a najvyššiu kvalitu potvrdzuje písomná záruka, ktorá môže byť až 60 rokov. Za reputáciou výrobkov BlachotrapezU stojí kvalita surovín - firma spolupracuje len s tými najlepšími a je výhradným distribútorom najvyššej kvality povrchových úprav od spoločnosti thyssenkrupp Steel Europe či TATA Steel.

S nami môžete dosiahnuť všetky sny o ideálnom dome. Dom s krásnou a pevnou strechou, ktorá zabezpečí komfort celej rodine.

Maloobchodný cenník je uvádzaný v mene EUR (€) v základných cenách bez DPH a aj v cenách vrátane DPH.

Obrázky sú len ilustračné, ich prevedenie a farebný odtieň sa môže od skutkového stavu líšiť.

Spoločnosť Blachotrapez si vyhradzuje pravo vykonávať cenové a sortimentové zmeny.

POZOR!

Povinný príplatok za ochrannú fóliu:

Príplatok 0,43 (0,53)/m² bez DPH (vč DPH)

Príplatok za malú objednávku:

Do 30 m² 0,96 (1,18)/m² bez DPH (s DPH)

BTR SYSTEMS

 **BLACHOTRAPEZ**®

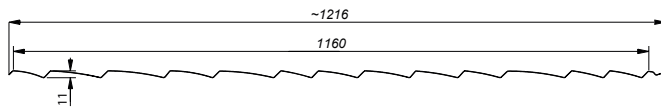

Celková šírka:	1216 mm
Krycia šírka:	1160 mm
Výška prelisu:	38 mm
Dĺžka modulu:	380 mm
Dĺžka plechu:	430 mm
Výška pretlačenia:	11 mm
Spotřeba ks/m ² :	2,27 ks
Minimální sklon:	14°

Thunder

Povrchová úprava

Písomná
záruka

Merná
jednotka

Cena
bez DPH

Cena
s DPH

Kamenný granulát

60 rokov

m²

27,41

33,71

Kamenný granulát

60 rokov

ks

12,07

14,85

Barevné prevedení:



Onyx



Amber



Hematit



Jade



Bronzite



BLIZZARD

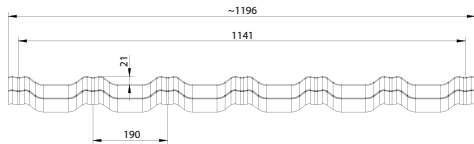

Celková šírka:	1196 mm
Krycia šírka:	1141 mm
Výška prelisu:	35 mm
Dĺžka modulu:	370 mm
Dĺžka plechu:	430 mm
Výška pretlačenia:	21 mm
Spotreba ks/m ² :	2,37 ks
Minimální sklon:	14°

Blizzard

Povrchová úprava

Písomná
záruka

Merná
jednotka

Cena
bez DPH

Cena
s DPH

Kamenný granulát

60 rokov

m²

26,83

33,00

Kamenný granulát

60 rokov

ks

11,32

13,92

Barevné provedení:



Onyx



Amber



Hematit



Ruby



Bronzite

STORM

Celková šírka:	1359 mm
Krycia šírka:	1312 mm
Výška prelisu:	35 mm
Dĺžka modulu:	370 mm
Dĺžka plechu:	425 mm
Výška pretlačenia:	7 mm
Spotřeba ks/m ² :	2,06 ks
Minimální sklon:	14°

Storm

Povrchová úprava

Kamenný granulát

Kamenný granulát

 Písomná
záruka

60 rokov

60 rokov

 Merná
jednotka

 m²

ks

 Cena
bez DPH

22,20

10,77

 Cena
s DPH

27,30

13,25

Barevné provedení:



Onyx



Amber



Hematit



Jade



Bronzite



mistral

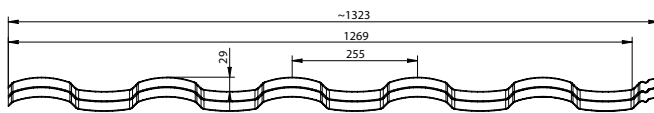

Celková šírka:	~1323 mm
Krycia šírka:	1269 mm
Výška prelisu:	20 mm
Dĺžka modulu:	370 mm
Dĺžka plechu:	425 mm
Výška pretlačenia:	29 mm
Spotřeba ks/m ² :	2,13 ks
Minimální sklon:	14°

Mistral

Povrchová úprava

Písomná
záruka

Merná
jednotka

Cena
bez DPH

Cena
s DPH

Kamenný granulát

60 rokov

m²

26,83

33,00

Kamenný granulát

60 rokov

ks

12,60

15,49

Barevné provedení:



Onyx



Amber



Hematit



Ruby



Bronzite

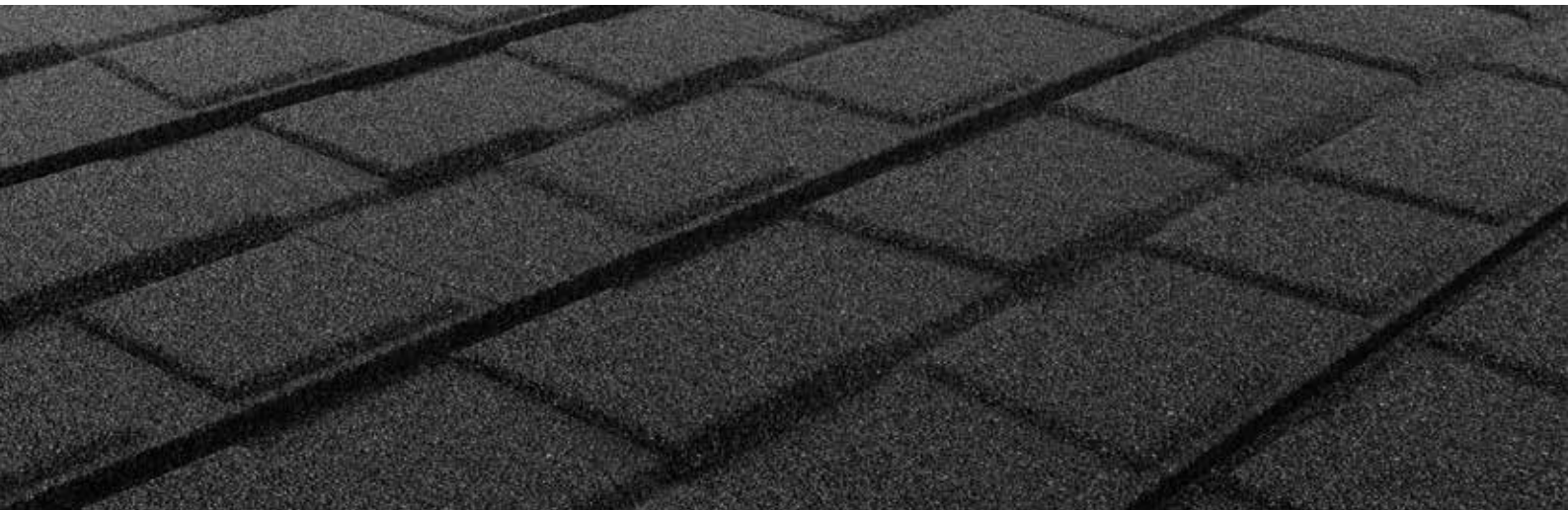

POLAR

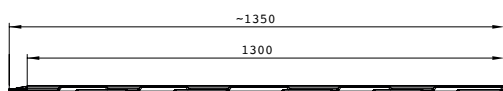

Celková šírka:	1350 mm
Krycia šírka:	1300 mm
Výška prelisu:	13 mm
Dĺžka modulu:	367 mm
Dĺžka plechu:	415 mm
Výška pretlačenia:	13 mm
Spotreba ks/m ² :	2,1 ks
Minimálny sklon:	14°

Polar

Povrchová úprava

Kamenný granulát

Kamenný granulát

Písomná záruka	Merná jednotka	Cena bez DPH	Cena s DPH
60 rokov	m ²	26,83	33,00
60 rokov	ks	12,71	15,64

POLAR HIGH

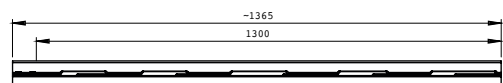

Celková šírka:	1365 mm
Krycia šírka:	1300 mm
Výška prelisu:	32 mm
Dĺžka modulu:	370 mm
Dĺžka plechu:	420 mm
Výška pretlačenia:	13 mm
Spotreba ks/m ² :	2,1 ks
Minimálny sklon:	14°

Polar High

Povrchová úprava

Kamenný granulát

Kamenný granulát

Písomná záruka	Merná jednotka	Cena bez DPH	Cena s DPH
60 rokov	m ²	26,83	33,00
60 rokov	ks	12,71	15,64

Barevné prevedení:



Onyx



Amber



Hematit



Jade



Bronzite



BTR SYSTEMS - tabulový plech 1250x460

Povrchová úprava

Cena/ks
bez DPHCena/ks
s DPH

Kamenný granulát

19,09

23,48



BTR SYSTEMS - Hrebenáče

Typ

mm

Cena/ks
bez DPHCena/ks
s DPH

Hrebenáč dlhý - Thunder, Storm, Bolt

1988

32,85

40,41

Hrebenáč modulový - Thunder, Storm, Bolt

395

7,32

9,00

Hrebenáč 3 modulový polokruhový - Blizzard, Mistral

1030

18,29

22,50

Hrebenáč plochý - Polar, Polar High

1270

20,73

25,50

Štvorstranný hrebeň X dlhý/ 3-modul

-

72,93

89,70

Hrebeň T dlhý/polokruhový

-

72,93

89,70

T-kus Y (uhol 15-30 / 30-45) hrebeň dlhý/ polokruhový

-

72,93

89,70

Ukončenie hrebeňa polkruhove

-

41,46

51,00

Zakončenie hrebeňa dlhé

-

72,93

89,70

Zakončenie hrebeňa polkruhové

-

72,93

89,70



Hrebeň X



Hrebeň T



T-kus Y dlouhý (15-30)



T-kus Y polokruhový (30-45)



Ukončenie hrebeňa



Zakončenie hrebeňa



Zakončenie hrebeňa



BTR SYSTEMS - lemovanie

Záveterná lišta profilovaná / Oplechovanie k stene 370 Storm

1250

24,64

30,31

Záveterná lišta profilovaná / Oplechovanie k stene 380 Thunder

1270

24,64

30,31

Záveterná lišta - UNI

2000

20,73

25,50

Podokapná lišta Mistral

2082

20,73

25,50

Oplechovanie k stene čelné A/B Mistral

2082

20,73

25,50

Štartovacia lišta / Oplechovanie k stene UNI (profil) Mistral

2082

20,73

25,50

Oplechovanie k stene UNI

2000

20,73

25,50



BTR SYSTEMS - ventilačné komínky

Sanitárny fi110

136,59

168,00

Sanitárny fi160

153,66

189,00

Strešný - Storm

97,32

119,70

Solárna prechodka

117,07

144,00

Srešný

109,50

134,69

Sanitárny

130,03

159,94



Fi 110



Fi 160



Strešný - Storm



Solárna prechodka



Srešný



Sanitárny

BTR SYSTEMS - doplnky

Kamenný granulát

1 kg

14,71

18,10

Servisní lepidlo

250 ml

10,97

13,50

Skrutky TX 20 4,8x35 9005 250 ks

-

23,32

28,69

Skrutky farmár BB 4,8x50 9005 250 ks

-

23,32

28,69

Ohábačka

-

701,22

862,50

Rezačka

-

981,71

1207,50



BTR SYSTEMS - podhrevenová lišta

18

1640

13,41

16,50

Modulové krytiny

 **BLACHOTRAPEZ®**

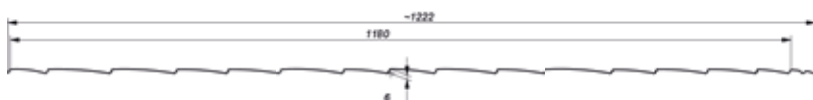

Celková šířka: 1222 mm
 Krycí šířka: 1180 mm
 Hrúbka (ocel): 0,5 mm

Výška profilu: 35 mm
 Délka modulu: 380 mm
 Výška prelisu: 6 mm

Jánošík

Povrchová úprava

Písomná záruka Merná jednotka Cena bez DPH Cena s DPH

Pladur® Relief Textured Wood	55 rokov	m ²	19,11	23,50
Pladur® Relief Textured Wood	55 rokov	ks	8,57	10,54

Jánošík - tabuľový plech 1250x200 mm

Povrchová úprava

Písomná záruka Merná jednotka Cena bez DPH Cena s DPH

Pladur® Relief Textured Wood	55 let	ks	41,67	51,25
------------------------------	--------	----	-------	-------

Jánošík - doplnky

Typ

Cena/ks bez DPH Cena/ks s DPH

Hrebenáč			21,89	26,93
Záveterná lišta Maryna			21,89	26,93
Oplechování k stene			21,89	26,93
Snehozábrana			2,27	2,79
UNI záveterná lišta (cena za bm) - max 5 bm			11,23	13,81

Jánošík - doplnky

Typ

Cena/ks bez DPH Cena/ks s DPH

KLINCOVAČKA NR22/90 Hans			597,50	734,93
SKRUTKO- KLINCE 28x50 (1 bal. = 1000 ks + 1x plyn)			158,30	194,71
SKRUTKO- KLINCE 28x50 (1 bal. = 2190 ks + 2x plyn)			247,56	304,50
Plyn ku klincom (1 ks)			14,14	17,39

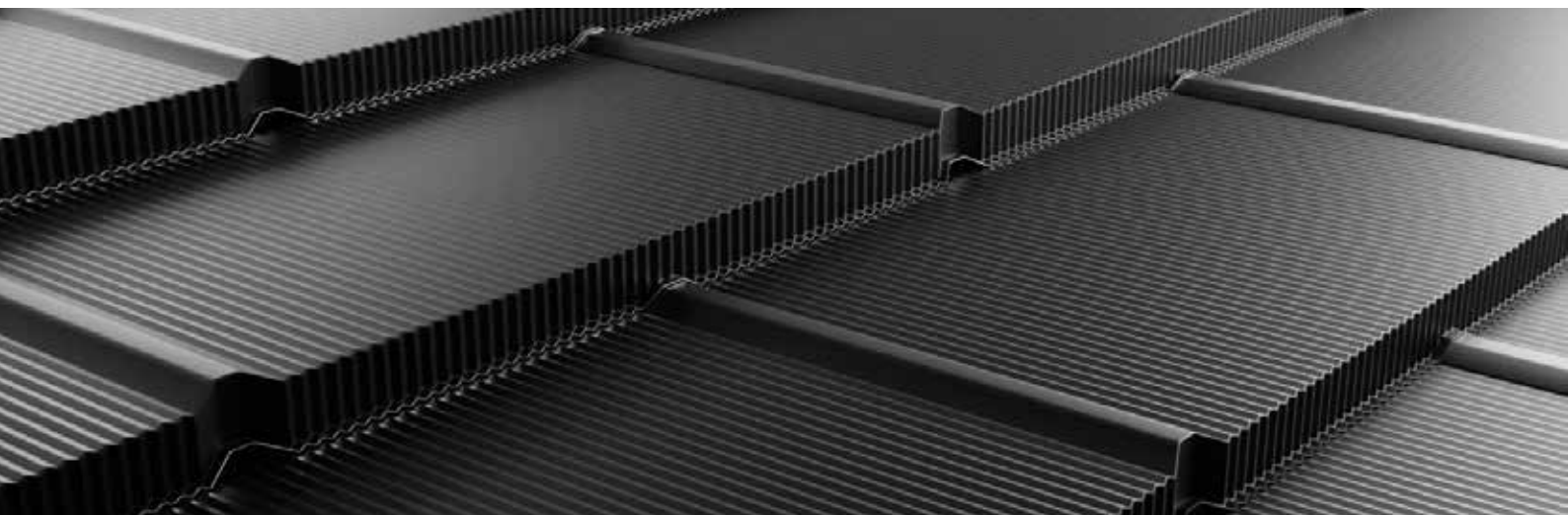

Kuga



Celková šírka: 1236 mm
Krycia šírka: 1180 mm
Hrúbka (ocel): 0,5 mm
Hrúbka (hliník): 0,6 mm

Výška pretlačenia: 35 mm
Dĺžka modulu: 350 mm
Výška prelisu: 7,6 mm

Kuga

Povrchová úprava

Pladur® Wrinkle mat

Pladur® Wrinkle Mat Plus

Hliník Stucco/MAT

	Hrúbka mm	Písomná záruka	Cena/ks bez DPH	Cena /ks s DPH
Pladur® Wrinkle mat	0,50	45 rokov	6,32	7,77
Pladur® Wrinkle Mat Plus	0,50	60 rokov	6,96	8,56
Hliník Stucco/MAT	0,60	60 rokov	9,00	11,07

Kuga line



Celková šírka: 1236 mm
Krycia šírka: 1190 mm
Hrúbka (ocel): 0,5 mm
Hrúbka (hliník): 0,6 mm

Výška pretlačenia: 30 mm
Dĺžka modulu: 350 mm
Výška prelisu: 7,6 mm

Kuga line

Povrchová úprava

Pladur® Wrinkle mat

Pladur® Wrinkle Mat Plus

Hliník Stucco/MAT

	Hrúbka mm	Písomná záruka	Cena/ks bez DPH	Cena /ks s DPH
Pladur® Wrinkle mat	0,50	45 rokov	11,90	14,63
Pladur® Wrinkle Mat Plus	0,50	60 rokov	13,10	16,11
Hliník Stucco/MAT	0,60	60 rokov	16,94	20,84



TREND

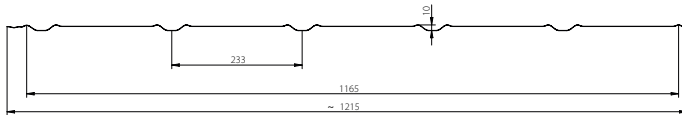

Celková šírka: 1215 mm
Krycia šírka: 1165 mm
Hrúbka (ocel): 0,5 mm

Výška pretlačenia: 30 mm
Dĺžka modulu: 350 mm
Výška prelisu: 10 mm

Trend

Povrchová úprava

Pladur® Wrinkle mat

Superior HB

Pladur® Relief IceCrystal

Pladur® Wrinkle Mat Plus

Hrúbka
mm

Písomná
záruka

Cena/ks
bez DPH

Cena /ks
s DPH

0,50

45 rokov

11,15

13,72

0,50

55 rokov

11,93

14,67

0,50

55 rokov

11,26

13,85

0,50

60 rokov

12,27

15,10



estima

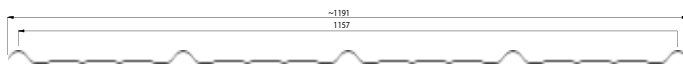

Celková šírka: 1191 mm
Krycia šírka: 1157 mm
Hrúbka (ocel): 0,5 mm
Hrúbka (hliník): 0,6 mm

Výška pretlačenia: 35 mm
Dĺžka tašky: 720 mm
Dĺžka modulu: 350 mm
Výška prelisu: 17,5 mm

Estima

Povrchová úprava

	Hrúbka mm	Písomná záruka	Cena/ks bez DPH	Cena /ks s DPH
Polyester štandard RAL - lesk	0,50	10 rokov	9,08	11,17
Pladur® RAL Premium	0,50	35 rokov	9,26	11,39
Pladur® Wrinkle mat	0,50	45 rokov	11,39	14,01
Pladur® Relief IceCrystal	0,50	55 rokov	11,50	14,14
Superior HB	0,50	55 rokov	12,18	14,98
Pladur® Wrinkle Mat Plus	0,50	60 rokov	12,54	15,43
Hliník Stucco/MAT	0,60	60 rokov	16,22	19,95



ENIGMA

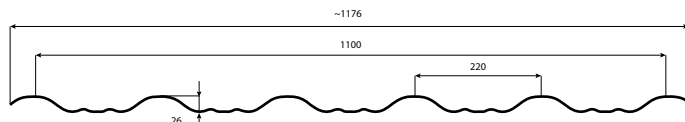

Celková šírka: 1176 mm
 Krycia šírka: 1100 mm
 Hrúbka (ocel): 0,5 mm
 Hrúbka (hliník): 0,6 mm

Výška pretlačenia: 30 mm
 Dĺžka tašky: 720 mm
 Dĺžka modulu: 350 mm
 Výška prelisu: 26 mm

Enigma

Povrchová úprava

	Hrúbka mm	Písomná záruka	Cena/ks bez DPH	Cena /ks s DPH
Polyester štandard RAL - lesk	0,50	10 rokov	8,97	11,03
Pladur® RAL Premium	0,50	35 rokov	9,14	11,24
Pladur® Wrinkle mat	0,50	45 rokov	11,24	13,83
Pladur® Relief IceCrystal	0,50	55 rokov	11,35	13,96
Superior HB	0,50	55 rokov	12,02	14,79
Pladur® Wrinkle Mat Plus	0,50	60 rokov	12,38	15,23
Hliník Stucco/MAT	0,60	60 rokov	16,01	19,70



TALIA

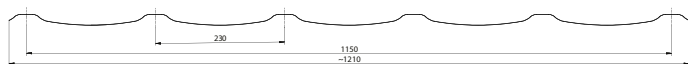

Celková šírka: 1210 mm
 Krycia šírka: 1150 mm
 Hrúbka (ocel): 0,5 mm
 Hrúbka (hliník): 0,6 mm

Výška pretlačenia: 30 mm
 Dĺžka tašky: 720 mm
 Dĺžka modulu: 350 mm
 Výška prelisu: 19 mm

Talia 30

Povrchová úprava

	Hrúbka mm	Písomná záruka	Cena/ks bez DPH	Cena/ks s DPH
Polyester štandard RAL - lesk	0,50	10 rokov	8,48	10,42
Pladur® RAL Premium	0,50	35 rokov	8,66	10,66
Pladur® Wrinkle mat	0,50	45 rokov	10,66	13,11
Pladur® Relief IceCrystal	0,50	55 rokov	10,76	13,24
Superior HB	0,50	55 rokov	11,40	14,02
Pladur® Wrinkle Mat Plus	0,50	60 rokov	11,85	14,57
Hliník Stucco/MAT	0,60	60 rokov	15,32	18,85



**Diamant[®]
plus**

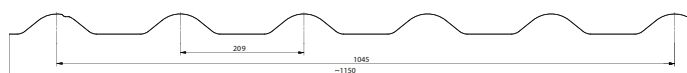

Celková šírka: 1150 mm
Krycia šírka: 1045 mm
Hrúbka (ocel): 0,5 mm
Hrúbka (hliník): 0,6 mm

Výška pretlačenia: 30 mm
Dĺžka tašky: 725 mm
Dĺžka modulu: 350 mm
Výška prelisu: 34 mm

Diamant Plus 30

Povrchová úprava

	Hrúbka mm	Písomná záruka	Cena/ks bez DPH	Cena /ks s DPH
Polyester štandard RAL - lesk	0,50	10 rokov	8,12	9,98
Pladur® RAL Premium	0,50	35 rokov	8,29	10,20
Pladur® Wrinkle mat	0,50	45 rokov	10,20	12,55
Pladur® Relief IceCrystal	0,50	55 rokov	10,30	12,67
Superior HB	0,50	55 rokov	10,91	13,42
Pladur® Wrinkle Mat Plus	0,50	60 rokov	11,34	13,95
Hliník Stucco/MAT	0,60	60 rokov	14,67	18,04

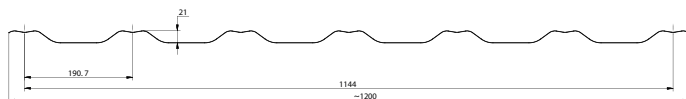

Celková šírka: 1200 mm
 Krycia šírka: 1144 mm
 Hrúbka (ocel): 0,5 mm
 Hrúbka (hliník): 0,6 mm

Výška pretlačenia: 30 mm
 Dĺžka tašky: 720 mm
 Dĺžka modulu: 350 mm
 Výška prelisu: 21 mm

German Simetric 30

Povrchová úprava

	Hrúbka mm	Písomná záruka	Cena/ks bez DPH	Cena /ks s DPH
Polyester štandard RAL - lesk	0,50	10 rokov	8,71	10,71
Pladur® RAL Premium	0,50	35 rokov	8,88	10,92
Pladur® Wrinkle mat	0,50	45 rokov	10,92	13,44
Pladur® Relief IceCrystal	0,50	55 rokov	11,03	13,57
Superior HB	0,50	55 rokov	11,68	14,37
Pladur® Wrinkle Mat Plus	0,50	60 rokov	12,03	14,80
Hliník Stucco/MAT	0,60	60 rokov	15,56	19,14



Germania
simetric

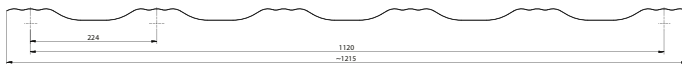

Celková šírka: 1215 mm
Krycia šírka: 1120 mm
Hrúbka (ocel): 0,5 mm
Hrúbka (hliník): 0,6 mm

Výška pretlačenia: 30 mm
Dĺžka tašky: 720 mm
Dĺžka modulu: 350 mm
Výška prelisu: 20 mm

Germania Simetric 30

Povrchová úprava

	Hrúbka mm	Písomná záruka	Cena/ks bez DPH	Cena /ks s DPH
Polyester štandard RAL - lesk	0,50	10 rokov	8,82	10,85
Pladur® RAL Premium	0,50	35 rokov	8,99	11,06
Pladur® Wrinkle mat	0,50	45 rokov	11,06	13,60
Pladur® Relief IceCrystal	0,50	55 rokov	11,17	13,74
Superior HB	0,50	55 rokov	11,83	14,55
Pladur® Wrinkle Mat Plus	0,50	60 rokov	12,18	14,98
Hliník Stucco/MAT	0,60	60 rokov	15,75	19,38

Krytyny
na mieru

 **BLACHOTRAPEZ**[®]



estima

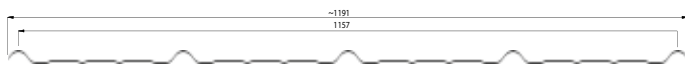

Celková šírka: 1191 mm
Krycia šírka: 1157 mm
Hrúbka (ocel): 0,5 mm
Hrúbka (hliník): 0,6 mm

Výška pretlačenia: 35 mm
Dĺžka (min-max): 720 - 4920 mm
Dĺžka modulu: 350 mm
Výška prelisu: 17,5 mm

Estima

Povrchová úprava

	Hrúbka mm	Písomná záruka	Cena/m ² bez DPH	Cena /m ² s DPH
Polyester štandard RAL - lesk	0,50	10 rokov	10,59	13,02
Polyester štandard MAT (AM)	0,50	35 rokov	12,17	14,97
Pladur® RAL Premium	0,50	35 rokov	11,33	13,94
Pladur® Wrinkle mat	0,50	45 rokov	13,94	17,14
Pladur® Relief IceCrystal	0,50	55 rokov	14,07	17,30
Superior HB	0,50	55 rokov	14,20	17,46
Pladur® Wrinkle Mat Plus	0,50	60 rokov	15,35	18,88
Hliník Stucco/MAT	0,60	60 rokov	18,91	23,25



ENIGMA

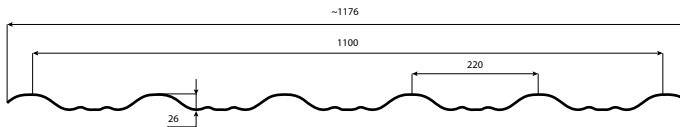

Celková šírka: 1176 mm
Krycia šírka: 1100 mm
Hrúbka (ocel): 0,5 mm
Hrúbka (hliník): 0,6 mm

Výška pretlačenia: 30 mm
Dĺžka (min-max): 720 - 5970 mm
Dĺžka modulu: 350 mm
Výška prelisu: 26 mm

Enigma

Povrchová úprava

	Hrúbka mm	Písomná záruka	Cena/m ² bez DPH	Cena /m ² s DPH
Polyester štandard RAL - lesk	0,50	10 rokov	10,59	13,02
Polyester štandard MAT (AM)	0,50	35 rokov	12,17	14,97
Pladur® RAL Premium	0,50	35 rokov	11,33	13,94
Pladur® Wrinkle mat	0,50	45 rokov	13,94	17,14
Pladur® Relief IceCrystal	0,50	55 rokov	14,07	17,30
Superior HB	0,50	55 rokov	14,20	17,46
Pladur® Wrinkle Mat Plus	0,50	60 rokov	15,35	18,88
Hliník Stucco/MAT	0,60	60 rokov	18,91	23,25



TALIA

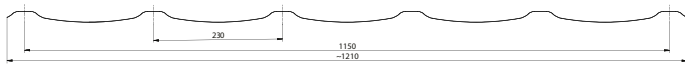

Celková šírka: 1210 mm
Krycia šírka: 1150 mm
Hrúbka (ocel): 0,5 mm
Hrúbka (hliník): 0,6 mm

Výška pretlačenia: 30 mm
Dĺžka (min-max): 720 - 5970 mm
Dĺžka modulu: 350 mm
Výška prelisu: 19 mm

Talia 30

Povrchová úprava

	Hrúbka mm	Písomná záruka	Cena/m ² bez DPH	Cena /m ² s DPH
Polyester štandard RAL - lesk	0,50	10 rokov	9,73	11,97
Polyester štandard MAT (AM)	0,50	35 rokov	11,21	13,79
Pladur® RAL Premium	0,50	35 rokov	10,44	12,84
Pladur® Wrinkle mat	0,50	45 rokov	12,84	15,80
Pladur® Relief IceCrystal	0,50	55 rokov	12,97	15,95
Superior HB	0,50	55 rokov	13,08	16,09
Pladur® Wrinkle Mat Plus	0,50	60 rokov	14,28	17,56
Hliník Stucco/MAT	0,60	60 rokov	17,59	21,63



GERMAN
simetric

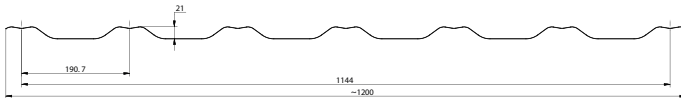

Celková šírka: 1200 mm
Krycia šírka: 1144 mm
Hrúbka (ocel): 0,5 mm
Hrúbka (hliník): 0,6 mm

Výška pretlačenia: 30 mm
Dĺžka tašky: 720 - 5970 mm
Dĺžka modulu: 350 mm
Výška prelisu: 21 mm

German Simetric 30

Povrchová úprava

	Hrúbka mm	Písomná záruka	Cena/m ² bez DPH	Cena /m ² s DPH
Polyester štandard RAL - lesk	0,50	10 rokov	10,08	12,40
Polyester štandard MAT (AM)	0,50	35 rokov	11,59	14,26
Pladur® RAL Premium	0,50	35 rokov	10,79	13,28
Pladur® Wrinkle mat	0,50	45 rokov	13,28	16,33
Pladur® Relief IceCrystal	0,50	55 rokov	13,40	16,49
Superior HB	0,50	55 rokov	13,52	16,63
Pladur® Wrinkle Mat Plus	0,50	60 rokov	14,62	17,98
Hliník Stucco/MAT	0,60	60 rokov	18,01	22,15



Germania
simetric

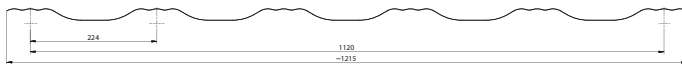

Celková šírka: 1215 mm
Krycia šírka: 1120 mm
Hrúbka (ocel): 0,5 mm
Hrúbka (hliník): 0,6 mm

Výška pretlačenia: 25/30 mm
Dĺžka (min - max): 720 - 5970 mm
Dĺžka modulu: 350 mm
Výška prelisu: 20 mm

Germania Simetric 25

Povrchová úprava

	Hrúbka mm	Písomná záruka	Cena/m ² bez DPH	Cena /m ² s DPH
Polyester štandard RAL - lesk	0,50	10 rokov	8,59	10,57
Polyester štandard MAT Innova	0,50	20 rokov	10,23	12,59
Polyester štandard MAT (AM)	0,50	35 rokov	11,03	13,56
Pladur® RAL Premium	0,50	35 rokov	10,47	12,88
Pladur® Wrinkle mat	0,50	45 rokov	12,88	15,84
Pladur® Relief IceCrystal	0,50	55 rokov	13,08	16,09
Superior HB	0,50	55 rokov	13,12	16,14
Pladur® Wrinkle Mat Plus	0,50	60 rokov	14,18	17,44
Hliník Stucco/MAT	0,60	60 rokov	17,47	21,49



Diament[®]
plus

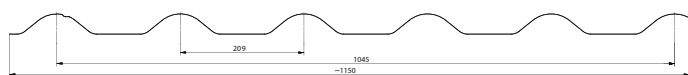

Celková šírka: 1150 mm
Krycia šírka: 1045 mm
Hrúbka (ocel): 0,5 mm
Hrúbka (hliník): 0,6 mm

Výška pretlačenia: 20 mm
Dĺžka (min - max): 850 - 5750 mm
Dĺžka modulu: 350 mm
Výška prelisu: 34 mm

Diament plus

Povrchová úprava

	Hrúbka mm	Písomná záruka	Cena/m ² bez DPH	Cena /m ² s DPH
Polyester štandard RAL - lesk	0,50	10 rokov	9,09	11,18
Polyester štandard MAT Innova	0,50	20 rokov	9,24	11,36
Polyester štandard MAT (AM)	0,50	35 rokov	10,67	13,12
Pladur [®] RAL Premium	0,50	35 rokov	10,34	12,72
Pladur [®] Wrinkle mat	0,50	45 rokov	12,71	15,64
Pladur [®] Relief IceCrystal	0,50	55 rokov	12,84	15,80
Superior HB	0,50	55 rokov	12,29	15,12
Pladur [®] Wrinkle Mat Plus	0,50	60 rokov	14,14	17,39
Hliník Stucco/MAT	0,60	60 rokov	17,41	21,41



Diament[®]
ECO
plus

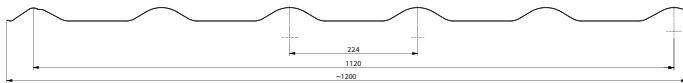

Celková šírka: 1200 mm
Krycia šírka: 1120 mm
Hrúbka (ocel): 0,5 mm
Hrúbka (hliník): 0,6 mm

Výška pretlačenia: 14 mm
Dĺžka (min - max): 850 - 5750 mm
Dĺžka modulu: 350 mm
Výška prelisu: 22 mm

Diament ECO plus

Hydrocontrol

Povrchová úprava

	Hrúbka mm	Písomná záruka	Cena/m ² bez DPH	Cena /m ² s DPH
Polyester štandard RAL - lesk	0,50	10 rokov	8,71	10,71
Polyester štandard MAT Innova	0,50	20 rokov	8,85	10,89
Polyester štandard MAT (AM)	0,50	35 rokov	10,22	12,57
Pladur [®] RAL Premium	0,50	35 rokov	9,91	12,19
Pladur [®] Wrinkle mat	0,50	45 rokov	12,19	14,99
Pladur [®] Relief IceCrystal	0,50	55 rokov	12,32	15,15
Superior HB	0,50	55 rokov	12,33	15,17
Pladur [®] Wrinkle Mat Plus	0,50	60 rokov	13,71	16,86
Hliník Stucco/MAT	0,60	60 rokov	16,88	20,76

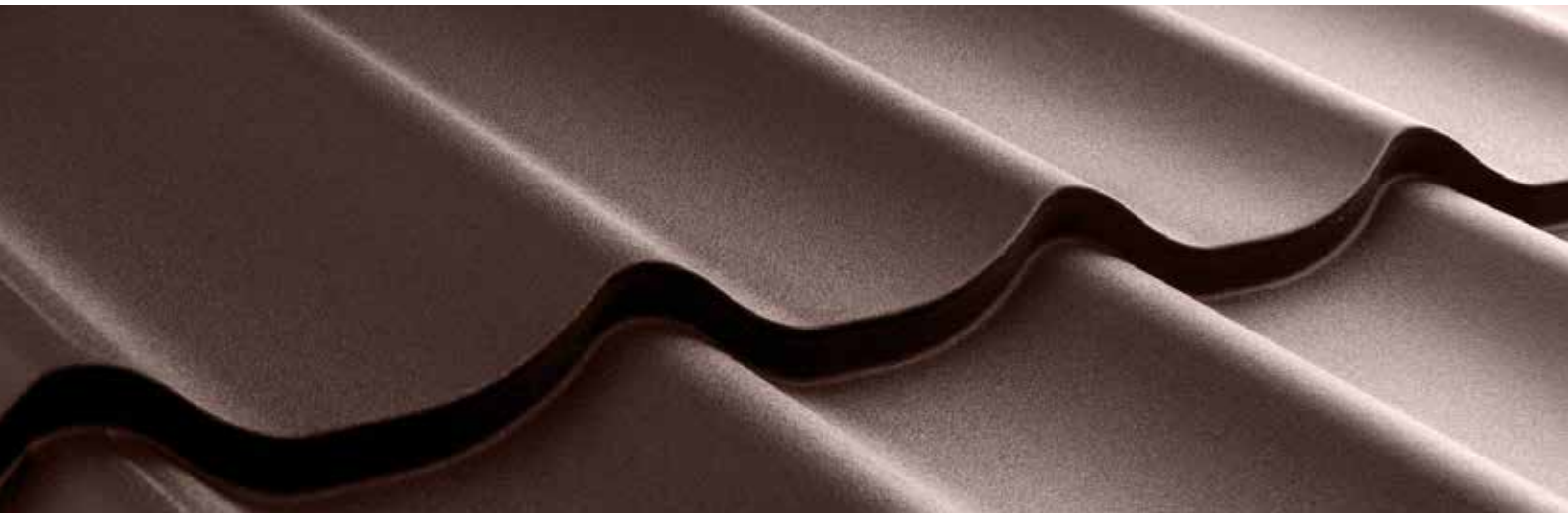

Kingas[®]
ECO
plus

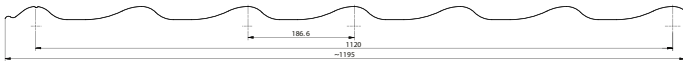

Celková šírka: 1195 mm
Krycia šírka: 1120 mm
Hrúbka (ocel): 0,5 mm
Hrúbka (hliník): 0,6 mm

Výška pretlačenia: 14 mm
Dĺžka (min - max): 850 - 5750 mm
Dĺžka modulu: 350 mm
Výška prelisu: 22 mm

Kingas Eco Plus

Povrchová úprava

	Hrúbka mm	Písomná záruka	Cena/m ² bez DPH	Cena /m ² s DPH
Polyester štandard RAL - lesk	0,50	10 rokov	8,71	10,71
Polyester štandard MAT Innova	0,50	20 rokov	8,85	10,89
Polyester štandard MAT (AM)	0,50	35 rokov	10,22	12,57
Pladur [®] RAL Premium	0,50	35 rokov	9,91	12,19
Pladur [®] Wrinkle mat	0,50	45 rokov	12,19	14,99
Pladur [®] Relief IceCrystal	0,50	55 rokov	12,32	15,15
Superior HB	0,50	55 rokov	12,33	15,17
Pladur [®] Wrinkle Mat Plus	0,50	60 rokov	13,71	16,86
Hliník Stucco/MAT	0,60	60 rokov	16,88	20,76

Trapézové krytiny

 **BLACHOTRAPEZ**®

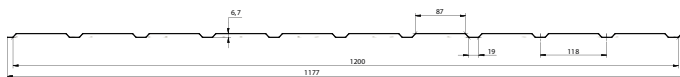
T-7|T-7 Pro

Celková šírka: 1200 mm
 Krycia šírka: 1177 mm
 Hrúbka (oceľ): 0,4 - 0,5 mm
 Hrúbka (hliník): 0,6 mm

Výška pretlačenia: 6,7 mm
 Dĺžka (max): 6000 mm

T-7|T-7 Pro - fasáda, podbitieHydrocontrol

Hydrocontrol pouze u profilu T-7

Povrchová úprava

Povrchová úprava	Hrúbka mm	Písomná záruka	Cena/m ² bez DPH	Cena /m ² s DPH
Pozink	0,50	2 roky	7,60 €	9,34 €
Aluzinok	0,50	25 rokov	7,01 €	8,62 €
Polyester štandard RAL - lesk	0,50	10 rokov	8,06 €	9,92 €
Polyester RAL drevedekor	0,50	10 rokov	13,38 €	16,46 €
Polyester štandard MAT Innova	0,50	20 rokov	8,20 €	10,09 €
Polyester štandard MAT (AM)	0,50	35 rokov	9,47 €	11,65 €
Pladur® RAL Premium	0,50	35 rokov	9,18 €	11,29 €
Pladur® Wrinkle mat	0,50	45 rokov	11,06 €	13,61 €
Pladur® Relief IceCrystal	0,50	55 rokov	11,22 €	13,80 €
Superior HB	0,50	55 rokov	10,70 €	13,17 €
Pladur® Wrinkle Mat Plus	0,50	60 rokov	12,30 €	15,13 €
Hliník Stucco/MAT	0,60	60 rokov	15,14 €	18,63 €
Pladur® Relief Textured Wood	0,50	55 rokov	13,84 €	17,02 €

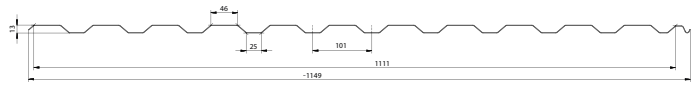
T-14+

Celková šírka: 1149 mm
Krycia šírka: 1111 mm
Hrúbka (oceľ): 0,5 - 0,7 mm
Hrúbka (hliník): 0,6 mm

Výška pretlačenia: 13 mm
Dĺžka (max): 8000 mm

T-14+ - strechaHydrocontrol

Povrchová úprava

	Hrúbka mm	Písomná záruka	Cena/m ² bez DPH	Cena /m ² s DPH
Aluzinok	0,50	25 rokov	7,32	9,00
Polyester štandard RAL - lesk	0,50	10 rokov	8,42	10,36
Polyester RAL drevodekor	0,50	10 rokov	13,98	17,19
Polyester štandard MAT Innova	0,50	20 rokov	8,57	10,54
Polyester štandard MAT (AM)	0,50	35 rokov	9,89	12,17
Pladur® RAL Premium	0,50	35 rokov	9,59	11,79
Pladur® Wrinkle mat	0,50	45 rokov	11,56	14,21
Pladur® Relief IceCrystal	0,50	55 rokov	11,72	14,41
Superior HB	0,50	55 rokov	11,18	13,75
Pladur® Wrinkle Mat Plus	0,50	60 rokov	12,85	15,80
Hliník Stucco/MAT	0,60	60 rokov	15,82	19,45
Pozink	0,50	2 roky	7,93	9,76

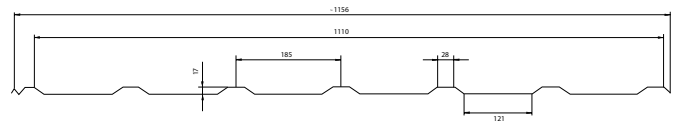
**T-18
Hydrocontrol**

Celková šírka: 1156 mm
Krycia šírka: 1110 mm
Hrúbka (oceľ): 0,5 - 0,7 mm
Hrúbka (hliník): 0,6 mm

Výška pretlačenia: 17 mm
Dĺžka (max): 10000 mm

T-18 HydrocontrolHydrocontrol

Aluzinok	0,50	25 rokov	8,59	10,56
Aluzinok	0,70	25 rokov	13,21	16,25
Polyester štandard RAL - lesk	0,50	10 rokov	9,70	11,93
Polyester štandard RAL - lesk	0,70	10 rokov	14,89	18,31
Polyester RAL drevodekor	0,50	10 rokov	14,94	18,37
Polyester štandard MAT Innova	0,50	20 rokov	9,81	12,07
Polyester štandard MAT (AM)	0,50	35 rokov	11,11	13,67
Pladur® RAL Premium	0,50	35 rokov	10,81	13,30
Pladur® Wrinkle mat	0,50	45 rokov	12,74	15,67
Pladur® Relief IceCrystal	0,50	55 rokov	12,90	15,86
Superior HB	0,50	55 rokov	12,37	15,21
Pladur® Wrinkle Mat Plus	0,50	60 rokov	14,00	17,21
Hliník Stucco/MAT	0,60	60 rokov	17,09	21,02

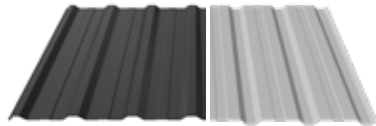
T-18+

Celková šírka: 1173 mm
 Krycia šírka: 1127 mm
 Hrúbka (ocel): 0,5 - 0,75 mm
 Hrúbka (hliník): 0,6 mm

Výška pretlačenia: 16,5 mm
 čenia: 12000 mm
 Dĺžka (max):

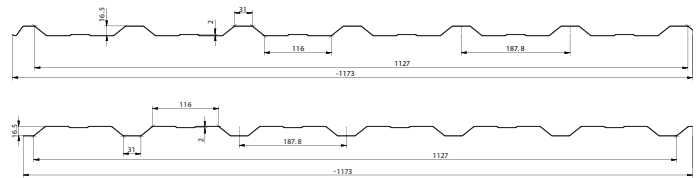
**T-18+ - strecha, fasáda**Hydrocontrol

Aluzinok	0,50	25 rokov	7,17	8,82
Aluzinok	0,70	25 rokov	11,79	14,50
Polyester štandard RAL - lesk	0,50	10 rokov	8,25	10,15
Polyester štandard RAL - lesk	0,63	10 rokov	10,48	12,89
Polyester štandard RAL - lesk	0,70	10 rokov	13,51	16,61
Polyester RAL drevodekor	0,50	10 rokov	13,54	16,65
Polyester štandard MAT Innova	0,50	20 rokov	8,39	10,32
Polyester štandard MAT (AM)	0,50	35 rokov	9,69	11,92
Pladur® RAL Premium	0,50	35 rokov	9,39	11,55
Pladur® Wrinkle mat	0,50	45 rokov	11,32	13,92
Pladur® Relief IceCrystal	0,50	55 rokov	11,48	14,12
Superior HB	0,50	55 rokov	10,95	13,47
Pladur® Wrinkle Mat Plus	0,50	60 rokov	12,58	15,48
Hliník Stucco/MAT	0,60	60 rokov	15,49	19,05
Pozink	0,50	2 roky	7,77	9,56
Presvetľovacie profil	1,00	-	22,00	27,06

T-20+

Celková šírka: 1120 mm

Krycia šírka: 1070 mm

Hrúbka (ocel): 0,5 - 0,75 mm

Výška pretlačenia: 19 mm

Dĺžka (max): 12000 mm

T-20+ - strechaHydrocontrol

Povrchová úprava

	Hrúbka mm	Písomná záruka	Cena/m ² bez DPH	Cena /m ² s DPH
Aluzinok	0,50	25 rokov	7,51	9,23
Aluzinok	0,70	25 rokov	12,35	15,19
Polyester štandard RAL - lesk	0,50	10 rokov	8,64	10,63
Polyester štandard RAL - lesk	0,63	10 rokov	10,98	13,50
Polyester štandard RAL - lesk	0,70	10 rokov	14,15	17,40
Polyester RAL drevedekor	0,50	10 rokov	14,18	17,44
Polyester štandard MAT Innova	0,50	20 rokov	8,79	10,81
Polyester štandard MAT (AM)	0,50	35 rokov	10,15	12,48
Pladur® RAL Premium	0,50	35 rokov	9,84	12,10
Pladur® Wrinkle mat	0,50	45 rokov	11,86	14,58
Pladur® Relief IceCrystal	0,50	55 rokov	12,02	14,78
Superior HB	0,50	55 rokov	11,47	14,11
Pladur® Wrinkle Mat Plus	0,50	60 rokov	13,18	16,21
Pozink	0,50	2 roky	8,14	10,01

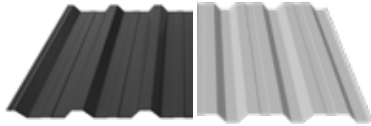
T-35+

Celková šírka: 1100 mm

Krycia šírka: 1065 mm

Hrúbka plechu (ocel): 0,5 - 1,00 mm

Výška pretlačenia: 34 mm

Dĺžka (max): 12000 mm

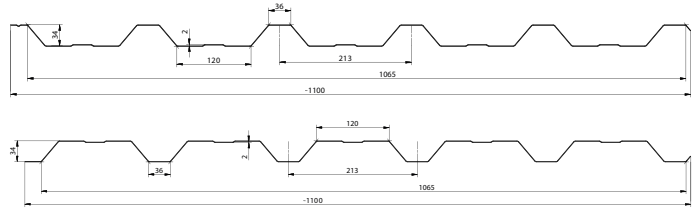
**T-35+ - strecha, fasáda**Hydrocontrol

Povrchová úprava

	Hrúbka mm	Písomná záruka	Cena/m ² bez DPH	Cena /m ² s DPH
Aluzinok	0,50	25 rokov	7,64	9,40
Aluzinok	0,70	25 rokov	12,57	15,46
Polyester štandard RAL - lesk	0,50	10 rokov	8,80	10,82
Polyester štandard RAL - lesk	0,63	10 rokov	11,18	13,75
Polyester štandard RAL - lesk	0,70	10 rokov	14,40	17,72
Polyester štandard RAL - lesk	0,75	10 rokov	14,58	17,93
Polyester štandard MAT Innova	0,50	20 rokov	8,95	11,01
Polyester štandard MAT (AM)	0,50	35 rokov	10,33	12,71
Pladur® RAL Premium	0,50	35 rokov	10,02	12,32
Pladur® Wrinkle mat	0,50	45 rokov	12,07	14,85
Pladur® Relief IceCrystal	0,50	55 rokov	12,24	15,05
Superior HB	0,50	55 rokov	11,68	14,36
Pladur® Wrinkle Mat Plus	0,50	60 rokov	13,42	16,50
Pozink	0,50	2 roky	8,29	10,19
Presvetľovacie profil	1,00	-	22,00	27,06

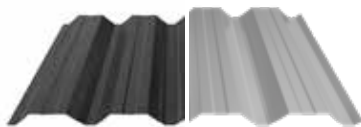
T-50

Celková šírka: 1098 mm

Krycia šírka: 1047 mm

Hrúbka (ocel): 0,5 - 1,00 mm

Výška pretlačenia: 49 mm

Dĺžka (max): 12000 mm

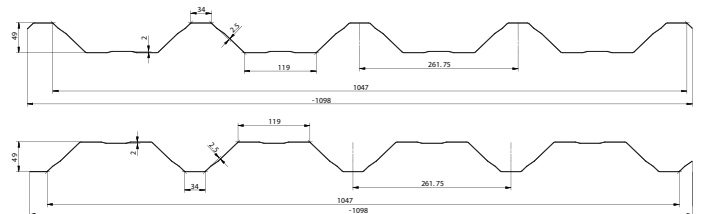
**T-50 - strecha, fasáda**Hydrocontrol

Povrchová úprava

	Hrúbka mm	Písomná záruka	Cena/m ² bez DPH	Cena /m ² s DPH
Aluzinok	0,50	25 rokov	7,66	9,42
Aluzinok	0,70	25 rokov	12,59	15,49
Polyester štandard RAL - lesk	0,50	10 rokov	8,81	10,84
Polyester štandard RAL - lesk	0,63	10 rokov	11,20	13,77
Polyester štandard RAL - lesk	0,70	10 rokov	14,43	17,75
Polyester štandard RAL - lesk	0,75	10 rokov	14,61	17,97
Polyester štandard MAT Innova	0,50	20 rokov	8,96	11,03
Polyester štandard MAT (AM)	0,50	35 rokov	10,35	12,73
Pladur® RAL Premium	0,50	35 rokov	10,03	12,34
Pladur® Wrinkle mat	0,50	45 rokov	12,09	14,87
Pladur® Relief IceCrystal	0,50	55 rokov	12,26	15,08
Superior HB	0,50	55 rokov	11,70	14,39
Pladur® Wrinkle Mat Plus	0,50	60 rokov	13,44	16,53
Pozink	0,50	2 roky	8,30	10,21

Strešné panely

 **BLACHOTRAPEZ**®



TERRANO

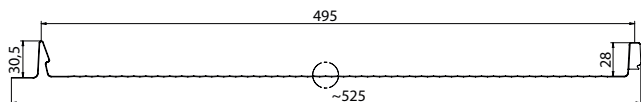

Celková šírka: **525 mm**
 Krycia šírka: **495 mm**
 Hrúbka (ocel): **0,5 mm**
 Hrúbka (hliník): **0,6 mm**

Výška zámku: **28 mm**
 Výška horného zámku: **30,5 mm**
 Dĺžka (min - max): **1400 - 8000 mm**

Voliteľné možnosti povrchu:

G Hladké **P** Protlačení
M Minivlna **N** Nanovlna**

**Nedostupné v provedení AL STUCCO

Terrano 30/525

Povrchová úprava

	Hrúbka mm	Písomná záruka	Cena/m ² bez DPH	Cena /m ² s DPH
Polyester štandard RAL - lesk	0,50	10 rokov	11,71	14,40
Polyester RAL drevodekor	0,50	10 rokov	16,83	20,70
Polyester štandard MAT (AM)	0,50	35 rokov	13,13	16,14
Pladur® RAL Premium	0,50	35 rokov	12,58	15,48
Pladur® Wrinkle mat	0,50	45 rokov	15,30	18,82
Pladur® Relief IceCrystal	0,50	55 rokov	15,46	19,01
Pladur® Relief Textured Wood	0,50	55 rokov	16,65	20,48
Superior HB	0,50	55 rokov	14,04	17,27
Pladur® Wrinkle Mat Plus	0,50	60 rokov	15,71	19,33
Hliník Stucco/MAT	0,60	60 rokov	19,26	23,69



TERRANO

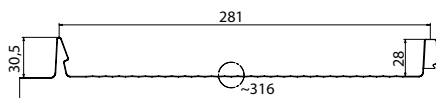
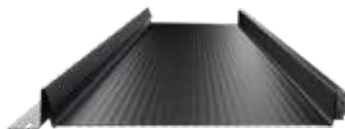

Celková šírka: **316 mm**
 Krycia šírka: **281 mm**
 Hrúbka (oceľ): **0,5 mm**
 Hrúbka (hliník): **0,6 mm**

Výška zámku: **28 mm**
 Výška horného zámku: **30,5 mm**
 Dĺžka (min - max): **1400 - 8000 mm**

Voliteľné možnosti povrchu:

G Hladké **P** Protlačení
M Minivlna **N** Nanovlna**

**Nedostupné v provedení AL STUCCO

Terrano 30/316

Povrchová úprava	Hrúbka mm	Písomná záruka	Cena/m ² bez DPH	Cena /m ² s DPH
Polyester štandard RAL - lesk	0,50	10 rokov	15,06	18,52
Polyester RAL drevodekor	0,50	10 rokov	20,81	25,59
Polyester štandard MAT (AM)	0,50	35 rokov	16,74	20,59
Pladur® RAL Premium	0,50	35 rokov	16,06	19,75
Pladur® Wrinkle mat	0,50	45 rokov	19,35	23,80
Pladur® Relief IceCrystal	0,50	55 rokov	19,51	23,99
Pladur® Relief Textured Wood	0,50	55 rokov	20,27	24,93
Superior HB	0,50	55 rokov	17,72	21,79
Pladur® Wrinkle Mat Plus	0,50	60 rokov	19,76	24,31
Hliník Stucco/MAT	0,60	60 rokov	23,81	29,28

TERRANO

— IZO —

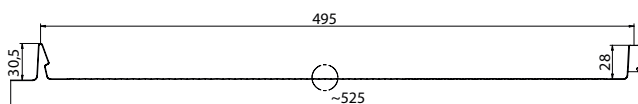

Celková šírka: **525 mm**
 Krycia šírka: **495 mm**
 Hrúbka (oceľ): **0,5 mm**

Výška zámku: **28 mm**
 Výška horného zámku: **30,5 mm**
 Dĺžka (min - max): **1400 - 8000 mm**

Terrano IZO 30/525

Povrchová úprava	Hrúbka mm	Písomná záruka	Cena/m ² bez DPH	Cena /m ² s DPH
Polyester štandard RAL - lesk	0,50	10 rokov	17,37	21,36
Polyester RAL drevodekor	0,50	10 rokov	23,39	28,77
Polyester štandard MAT (AM)	0,50	35 rokov	19,72	24,25
Pladur® RAL Premium	0,50	35 rokov	18,56	22,83
Pladur® Wrinkle mat	0,50	45 rokov	22,09	27,17
Pladur® Relief IceCrystal	0,50	55 rokov	22,28	27,40
Pladur® Relief Textured Wood	0,50	55 rokov	22,24	27,36
Superior HB	0,50	55 rokov	20,74	25,51
Pladur® Wrinkle Mat Plus	0,50	60 rokov	22,50	27,68



PANEL™
HIGH-TECH

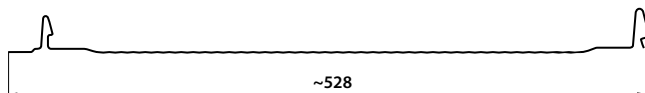

Celková šírka: 528 mm
Krycia šírka: 495 mm
Hrúbka (oceľ): 0,5 mm

Výška zámku: 32 mm
Výška horného zámku: 27 mm
Dĺžka (max): 8000 mm

High-tech panel NANO

Hydrocontrol

Povrchová úprava

	Hrúbka mm	Písomná záruka	Cena/m ² bez DPH	Cena /m ² s DPH
Polyester štandard RAL - lesk	0,50	10 rokov	11,52	14,17
Polyester RAL drevo dekor	0,50	10 rokov	16,64	20,47
Polyester štandard MAT Innova	0,50	20 rokov	11,90	14,64
Polyester štandard MAT (AM)	0,50	35 rokov	12,91	15,88
Pladur® RAL Premium	0,50	35 rokov	12,44	15,31
Pladur® Wrinkle mat	0,50	45 rokov	15,05	18,51
Pladur® Relief IceCrystal	0,50	55 rokov	15,20	18,70
Pladur® Relief Textured Wood	0,50	55 rokov	16,51	20,30
Superior HB	0,50	55 rokov	13,81	16,99
Pladur® Wrinkle Mat Plus	0,50	60 rokov	15,46	19,01



**PANEL RETRO
25**

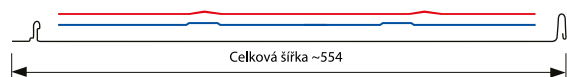

Celková šírka: 554 mm
Krycia šírka: 521 mm
Hrúbka (ocel): 0,5 mm
Hrúbka (hliník): 0,6 - 0,7 mm

Výška zámku: 25 mm
Dĺžka (min - max): 1400 - 8000 mm

Retro panel 25/554

Hydrocontrol

Povrchová úprava

	Hrúbka mm	Písomná záruka	Cena/m ² bez DPH	Cena /m ² s DPH
Aluzinok	0,50	25 rokov	8,95	11,00
Polyester štandard RAL - lesk	0,50	10 rokov	11,19	13,76
Polyester RAL drevodekor	0,50	10 rokov	16,16	19,87
Polyester štandard MAT Innova	0,50	20 rokov	11,55	14,21
Polyester štandard MAT (AM)	0,50	35 rokov	12,53	15,42
Pladur® RAL Premium	0,50	35 rokov	12,08	14,86
Pladur® Wrinkle mat	0,50	45 rokov	14,61	17,97
Pladur® Relief IceCrystal	0,50	55 rokov	14,76	18,16
Pladur® Relief Textured Wood	0,50	55 rokov	16,03	19,71
Superior HB	0,50	55 rokov	13,41	16,49
Pladur® Wrinkle Mat Plus	0,50	60 rokov	15,02	18,47
Hliník Stucco/MAT	0,60	60 rokov	18,39	22,62
Hliník MAT	0,70	60 rokov	18,44	22,68



Celková šírka: **340 mm**
 Krycia šírka: **309 mm**
 Hrúbka (ocel): **0,5 mm**
 Hrúbka (hliník): **0,6 mm**

Výška zámku: **25 mm**
 Dĺžka (min - max): **1400 - 8000 mm**

Retro panel 25/340

Hydrocontrol

Povrchová úprava

Povrchová úprava	Hrúbka mm	Písomná záruka	Cena/m ² bez DPH	Cena /m ² s DPH
Aluzinok	0,50	25 rokov	11,61	14,29
Polyester štandard RAL - lesk	0,50	10 rokov	14,10	17,34
Polyester RAL drevodekor	0,50	10 rokov	19,51	24,00
Polyester štandard MAT Innova	0,50	20 rokov	14,44	17,76
Polyester štandard MAT (AM)	0,50	35 rokov	15,66	19,26
Pladur® RAL Premium	0,50	35 rokov	15,10	18,57
Pladur® Wrinkle mat	0,50	45 rokov	18,08	22,24
Pladur® Relief IceCrystal	0,50	55 rokov	18,23	22,43
Pladur® Relief Textured Wood	0,50	55 rokov	19,13	23,53
Superior HB	0,50	55 rokov	16,62	20,45
Pladur® Wrinkle Mat Plus	0,50	60 rokov	18,49	22,74
Hliník Stucco/MAT	0,60	60 rokov	22,22	27,34



T-PANEL

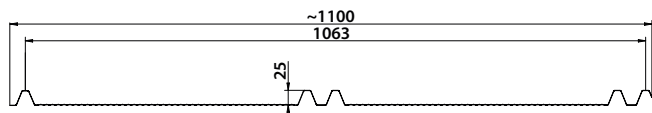
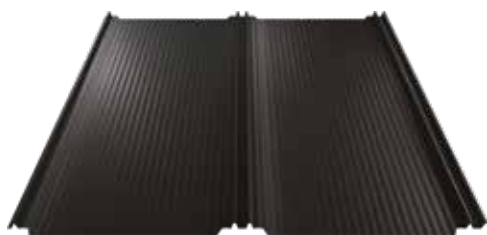

Celková šírka: 1100 mm
 Krycia šírka: 1063 mm
 Hrúbka (ocel): 0,5 mm
 Hrúbka (hliník): 0,6 mm

Výška zámku: 25 mm
 Dĺžka (max): 8000 mm

T-PANEL

Povrchová úprava	Hrúbka mm	Písomná záruka	Cena/m ² bez DPH	Cena /m ² s DPH
Polyester štandard RAL - lesk	0,50	10 rokov	9,59	11,80
Polyester RAL drevodekor	0,50	10 rokov	14,69	18,07
Polyester štandard MAT Innova	0,50	20 rokov	9,95	12,24
Polyester štandard MAT (AM)	0,50	35 rokov	11,13	13,69
Pladur® RAL Premium	0,50	35 rokov	10,27	12,63
Pladur® Wrinkle mat	0,50	45 rokov	12,34	15,18
Pladur® Relief IceCrystal	0,50	55 rokov	12,49	15,37
Superior HB	0,50	55 rokov	11,95	14,70
Pladur® Wrinkle Mat Plus	0,50	60 rokov	13,65	16,79
Pladur® Relief Textured Wood	0,50	55 rokov	15,37	18,91
Hliník Stucco/MAT	0,60	60 rokov	16,81	20,68



Odkvapový systém

 **BLACHOTRAPEZ**®

Žľab



Rozmer	Balenie ks	Cena/ks bez DPH	Cena/ks s DPH
75 x 2000	5/265	5,21	6,41
75 x 3000	5/265	7,82	9,62
75 x 4000	5/265	10,42	12,82
100 x 2000	5/105	7,27	8,94
100 x 3000	5/105	10,91	13,42
100 x 4000	5/105	14,55	17,90
130 x 2000	5/90	9,15	11,25
130 x 3000	5/90	13,72	16,88
130 x 4000	5/90	18,30	22,51
150 x 3000	5/75	16,73	20,58
150 x 4000	5/75	22,31	27,44

Čelo (ľavé/pravé)



75	75/6000	1,75	2,16
100	24/1920	2,19	2,70
130	72/2304	3,14	3,86
150	32/1024	3,30	4,06

Žľabová spojka



75	20/1600	3,88	4,78
100	18/920	4,96	6,10
130	12/384	6,28	7,73
150	8/256	6,36	7,82

Čelový hák



75	60/4800	1,52	1,87
100	30/2400	2,02	2,48
130	12/384	2,18	2,68
150	40/1280	2,20	2,71

Hák na krokvu



100	40/1920	4,02	4,94
130	25/1200	4,59	5,65
150	20/960	4,67	5,74

Roh/Kout 90°



75	8/640	5,52	6,79
100	4/320	6,13	7,54
130	6/192	7,22	8,88
150	3/96	14,78	18,18

Roh/Kout (individuálny uhol)



75	1	23,72	29,18
100	1	27,42	33,73
130	1	31,05	38,19
150	1	29,17	35,88

Kotlík



75/63	10/800	5,83	7,17
100/63	4/320	5,85	7,20
100/90	4/320	5,85	7,20
130/90	8/256	7,75	9,53
150/110	3/96	10,15	12,49

Koleno



63/67°	16/960	3,91	4,81
90/67°	16/448	5,72	7,04
110/67°	8/256	5,76	7,08



Zvod

63 x 2000	5/120	6,71	8,26
63 x 3000	5/120	10,07	12,38
63 x 4000	5/120	13,42	16,51
90 x 2000	5/60	11,64	14,32
90 x 3000	5/60	17,46	21,48
90 x 4000	5/60	23,29	28,64
110 x 3000	5/30	21,98	27,03
110 x 4000	5/30	29,30	36,04



Zvodová spojka

63	24/1920	3,20	3,94
90	36/1152	4,07	5,00
110	24/768	4,08	5,02



Objímka

63	80/6400	1,70	2,09
90	48/3360	2,22	2,73
110	21/1680	2,22	2,74



Zvodová rozbočka

63	8/640	8,58	10,56
90	8/256	10,53	12,96
110	4/128	21,04	25,88



Skrutka objímky

100	100/6000	1,37	1,68
160	100/6000	1,54	1,89
200	100/6000	1,71	2,10
260	50/3000	1,88	2,31
300	50/3000	2,05	2,52



Ostatné

Typ	Rozmer mm	Balení ks	Cena/ks bez DPH	Cena /ks s DPH
Hmoždinka do izolačných materiálov s M8	95	4/80	4,40	5,41
Držiak na objímku k sendvičovému panelu	-	150/25200	2,10	2,59
Redukcia	90/63	24/1920	4,73	5,82
Gumová redukce	110/90	1/300	3,20	3,94
Kanalizačná vpusť (studnička) RAL 8017	63	1/100	13,72	16,87
Kanalizačná vpusť (studnička) RAL 8017	90	1/100	13,72	16,87
Zachytávač dažďovej vody	90/50	9/288	23,36	28,73
Revízia zvodovej rúry	90	10/320	23,36	28,73
Sieťka do žlabu	2 mb	1/600	13,06	16,07
Zátka pre lapač	50	12/4800	3,89	4,78
Kanalizačná vpusť (studnička) RAL 7016, 8017, 9005	63	1/100	8,82	10,85
Kanalizačná vpusť (studnička) RAL 7016, 8017, 9005	90	1/100	8,82	10,85
Vonkajší roh regulovateľný rozmedzí 120°-145°	130	-	20,98	25,80



SYSTEM

75/63



SYSTEM

100/63



SYSTEM

100/90



SYSTEM

130/90

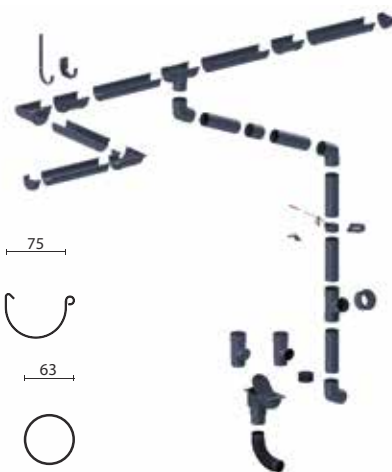
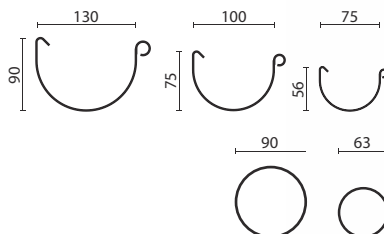

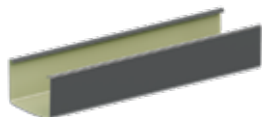

Hranatý žlab

Rozmer	Balenie ks	Cena/ks bez DPH	Cena/ks s DPH
135 x 3000	2 / 54	18,16	22,34
135 x 4000	2 / 54	24,21	29,78



Čelo (univerzálne)

135	64 / 2048	4,29	5,27
-----	-----------	------	------



Spojka žlabu

135	10 / 320	8,36	10,28
-----	----------	------	-------



Hák čelový PVC

135	50 / 1600	2,36	2,90
-----	-----------	------	------



Hák čelový

135	18 / 864	5,23	6,43
-----	----------	------	------



Hák na krokvu

135/240	12 / 567	5,23	6,43
---------	----------	------	------



Roh/Kút 90°

135	6 / 192	9,64	11,86
-----	---------	------	-------

Roh/Kút 135°

135	1	24,00	29,52
-----	---	-------	-------



Roh/Kút nastaviteľný 50-179°

135	6 / 192	54,21	66,68
-----	---------	-------	-------



Kotlík

135/80x80	6/192	9,64	11,86
-----------	-------	------	-------



Zvod hranatý

135 x 3000	2 / 54	19,29	23,72
135 x 4000	2 / 54	25,71	31,63



Koleno

135	64 / 2048	5,36	6,59
-----	-----------	------	------



Spojka zvodu

135	10 / 320	3,64	4,48
-----	----------	------	------

Objímka (bracket)

135	50 / 1600	3,43	4,22
-----	-----------	------	------



Tříň objímky M8

12 x 100	25 / 18000	0,50	0,61
12 x 160	25 / 12000	0,80	0,98
12 x 200	25 / 8000	1,12	1,37
12 x 260	25 / 6400	1,44	1,77
12 x 300	25 / 3600	1,92	2,36



Ostatné

Typ	Rozmer mm	Balenie ks	Cena/ks bez DPH	Cena /ks s DPH
Hmoždinka do izolačných materiálov s M8	95	4/80	4,40	5,41
Držiak objímky	-	150/25200	1,84	2,26
Kanalizačná vpusť	80x80/110	1/100	8,10	9,96
Tesnenie	80x80	1	0,47	0,58
Zachytávač dažďovej vody	80x80	9/288	27,65	34,01
Zvodová rozbočka	80x80x23°	8/256	33,01	40,60
Revízia zvodovej rúry	80x80	10/320	20,03	24,64
Zátka pre lapač	80x80	50/4000	9,32	11,47
Gumená redukcia	80x80/50	6/300	6,92	8,51



RAL 7016



RAL 9005



RAL 90 10

SYSTEM

135 / 80x80

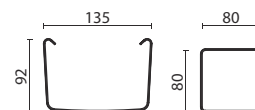

Žľab

Rozmer	Balenie ks	Cena/ks bez DPH	Cena/ks s DPH
125 x 3000*	1/140	14,35	17,64
125 x 4000*	1/140	19,13	23,52
125 x 5000*	1/140	23,91	29,41
125 x 6000*	1/140	28,69	35,29
130 x 3000	1/140	15,99	19,66
130 x 4000	1/140	21,32	26,22
150 x 3000	1/100	18,73	23,03
150 x 4000	1/100	24,97	30,71
150 x 5000*	1/80	31,21	38,38
150 x 6000*	1/80	37,45	46,07

Čelo (univerzálne)

125*	54/1728	2,71	3,33
130	36/1152	3,02	3,71
150	28/896	3,23	3,98

Žľabová spojka

125*	60/1920	3,46	4,25
130	60/1920	4,38	5,38
150	60/1920	5,13	6,31

Čelový hák

125*	30/1440	2,42	2,97
130	20/960	2,73	3,36
150	20/960	3,19	3,93

Hák na krokvu

125 x 300*	20/960	2,94	3,62
130 x 240	20/960	3,56	4,38
150 x 300	20/960	3,91	4,80

Roh/Kút 90°

125*	10/320	10,63	13,08
130	6/192	12,38	15,23
150	5/160	14,01	17,23

Roh/Kút (individuálny uhol)

130	1	36,62	45,04
150	1	38,08	46,84

Kotlík

125/90*	8/256	5,28	6,49
130/90	8/256	6,18	7,60
130/100	8/256	8,85	10,89
150/100	6/192	7,21	8,87
150/120	8/256	10,83	13,32

Zvod

90 x 1000	1/132	6,85	8,42
90 x 3000	1/66	20,54	25,27
90 x 4000	1/66	27,39	33,69
100 x 1000	1/120	7,80	9,60
100 x 3000	1/60	23,41	28,79
100 x 4000	1/60	31,21	38,39
120 x 1000	1/40	9,81	12,07
120 x 3000	1/40	29,59	36,39
120 x 4000	1/40	39,43	48,50

* Tovar dostupný iba na objednávku



Zvodová spojka

90	48/1536	4,76	5,85
100	36/1156	5,13	6,31
120	24/768	8,76	10,78



Koleno

90/60°	8/256	5,94	7,31
100/60°	6/192	7,00	8,62
120/72°	4/128	7,71	9,49



Objímka

90	48/1536	2,66	3,27
100	36/1156	3,11	3,83
120	24/768	4,25	5,23



Zvodová rozbočka Y

90	4/128	33,57	41,29
100	2/64	35,62	43,81



Skrutka objímky

100	25/18000	0,38	0,46
160	25/12000	0,60	0,74
200	25/8000	0,84	1,04
260	25/6400	1,08	1,33
300	25/3600	1,44	1,78



Zachytávač dažďovej vody

90	4/128	27,33	33,62
100	2/64	28,76	35,37



Ostatné

Typ	Rozmer mm	Balení ks	Cena/ks bez DPH	Cena /ks s DPH
Hmoždinka do izolačných materiálov s M8	95	4/80	4,40	5,41
Držiak na objímku k sendvičovému panelu	-	150/25200	1,45	1,78
Sieťka do žľabu 2bm	2 bm	1/600	9,04	11,12
Gumenná redukcia	110/90	1/300	2,22	2,73
Kanalizačná vpusť (studnička) RAL 8017	90 a 100	1/100	9,50	11,68
Tesnenie do žľabovej spojky	125	10	0,37	0,45
Tesnenie do žľabovej spojky	130	10	0,45	0,55
Tesnenie do žľabovej spojky	150	10	0,58	0,71
Tesnenie do čela žľabu	125	10	0,06	0,07
Tesnenie do čela žľabu	130	10	0,06	0,08
Tesnenie do čela žľabu	150	10	0,09	0,11
Zachytávač dažďovej vody	240x190x200	1	60,92	74,94
Kanalizačná vpusť RAL 7016, 8019, 9005	63 a 90	1/100	6,11	7,51



RAL 9007 RAL 3009 RAL 7016 RAL 8004 RAL 8018 RAL 8019 RAL 9005



RAL 7016 RAL 9005

SYSTEM

125/90

130/90

130/100

150/100

SYSTEM

150/120

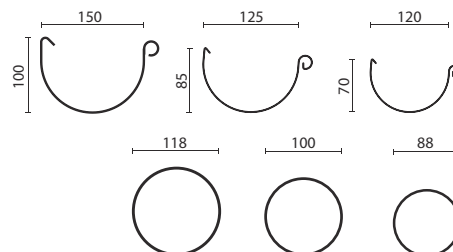

Žlab



Rozmer	Balenie ks	Cena/ks bez DPH	Cena /ks s DPH
125 x 3000*	1/140	13,04	16,04
125 x 4000*	1/140	17,38	21,38
130 x 3000	1/140	14,94	18,37
130 x 4000	1/140	19,92	24,50
150 x 3000	1/100	17,49	21,52
150 x 4000	1/100	23,33	28,69

Čelo (univerzálne)



125*	54/1728	2,00	2,46
130	36/1152	2,23	2,74
150	28/896	2,61	3,21

Žlabová spojka



125*	60/1920	3,14	3,86
130	60/1920	3,74	4,60
150	60/1920	4,38	5,39

Čelový hák



125	30/1440	2,14	2,63
130	20/960	2,39	2,93
150	20/960	2,79	3,43

Hák na krokvu



125 x 300*	20/960	2,21	2,71
130 x 240	20/960	3,10	3,82
150 x 300	20/960	3,42	4,21

Roh/Kout 90°



125*	10/320	8,74	10,75
130	6/192	9,71	11,94
150	5/160	11,30	13,90

Roh/Kút (nastaviteľný uhol)



130	1	26,64	32,77
150	1	27,71	34,09

Kotlík



125/90*	8/256	4,98	6,12
130/90	8/256	6,38	7,85
130/100	8/256	5,40	6,64
150/100	6/192	6,31	7,76

Zvod



90 x 1000	1/132	5,54	6,81
90 x 3000	1/66	16,61	20,43
90 x 4000	1/66	22,15	27,24
100 x 1000	1/120	6,48	7,98
100 x 3000	1/60	19,46	23,93
100 x 4000	1/60	25,94	31,91

Zvodová spojka



90	48/1536	3,69	4,54
100	36/1156	3,98	4,90

Koleno



90/60°	8/256	5,23	6,43
100/60°	6/192	6,19	7,61



Objímka

90	15/2520	2,32	2,86
100	10	2,72	3,34



Zvodová rozbočka Y

90	4/128	27,03	33,25
100	2/64	28,68	35,28



Skrutka objímky

100	25/18000	0,36	0,45
160	25/12000	0,58	0,72
200	25/8000	0,82	1,00
260	25/6400	1,05	1,29
300	25/3600	1,40	1,72

Zachytávač dažďovej vody

90	6/192	25,79	31,73
100	6/192	27,21	33,47



Ostatné

Typ	Rozmer mm	Balenie ks	Cena/ks bez DPH	Cena /ks s DPH
Hmoždinka do izolačných materiálov s M8	95	4/80	4,40	5,41
Držiak na objímku k sendvičovému panelu	-	150/25200	1,34	1,65
Sieťka do žľabu	2 bm	1/600	8,77	10,79
Gumenná redukcia	110/90	1/300	2,05	2,52
Kanalizační vpust' (gajgr) RAL 8017	90 a 100	1/100	9,21	11,33
Tesnenie do žľabovej spojky	125	10	0,36	0,44
Tesnenie do žľabovej spojky	130	10	0,43	0,53
Tesnenie do žľabovej spojky	150	10	0,56	0,69
Tesnenie do čela žľabu	125	10	0,05	0,07
Tesnenie do čela žľabu	130	10	0,06	0,07
Tesnenie do čela žľabu	150	10	0,09	0,11
Zachytávač dažďovej vody	240x190x200	1	59,10	72,70
Kanalizační vpust' (gajgr) RAL 7016, 8019, 9005	63 a 90	1/100	5,92	7,29



AZ Aluzinok

SYSTEM

125/90



AZ Aluzinok

SYSTEM

130/90



AZ Aluzinok

SYSTEM

130/100



AZ Aluzinok

SYSTEM

150/100

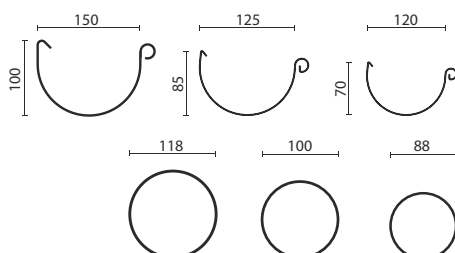



Žlab

Rozmer	Balenie ks	Cena/ks bez DPH	Cena/ks s DPH
135 x 3000	1/63	24,20	29,04
135 x 4000	1/63	32,26	38,71



Čelo (univerzálne)

135	56 / 1792	4,90	5,88
-----	-----------	------	------



Spojka žlabu

135	30 / 960	5,90	7,08
-----	----------	------	------



Hák čelový PVC

135	18/864	4,02	4,83
-----	--------	------	------



Hák na krokvu

135/240	12 / 567	4,02	4,83
---------	----------	------	------



Roh/kút 90°

135	4/128	23,06	27,76
-----	-------	-------	-------

Roh/kút nastaviteľný 50-179°

135	1	77,14	92,57
-----	---	-------	-------



Kotlík

135/80x80	6 / 192	13,22	15,87
-----------	---------	-------	-------



Zvod hranatý

80x80 x 1000	1/72	8,70	10,44
80x80 x 3000	1/84	26,11	31,33
80x80 x 4000	1/84	34,81	41,77



Koleno zvodu

80x80 x 60°	8/256	7,47	8,96
-------------	-------	------	------



Spojka zvodu

80x80	48/1563	10,47	12,56
-------	---------	-------	-------



Objímka zvodu - oceľ

80x80	12/206	4,01	4,81
-------	--------	------	------

Tíň objímky - M8

12 x 100	25 / 18000	0,43	0,51
12 x 160	25 / 12000	0,71	0,86
12 x 200	25 / 8000	1,00	1,20
12 x 260	25 / 6400	1,28	1,54
12 x 300	25 / 3600	1,71	2,05
12 x 350	25 / 3600	1,88	2,26





Zachytávač dažďovej vody

Rozmer	Balenie ks	Cena/ks bez DPH	Cena /ks s DPH
80x80	9/288	27,65	33,18

Revízia zvodovej rúry

80x80	10/320	20,03	24,03
-------	--------	-------	-------

Zátka pre lapač

80x80	50/4000	9,32	11,19
-------	---------	------	-------

Gumená redukcia

80x80/50	6/300	6,92	8,31
----------	-------	------	------

Ostatné prvky

Typ	Rozmer mm	Balenie ks	Cena/ks bez DPH	Cena /ks s DPH
Hmoždinka do izolačných materiálov s M8	95	4/80	4,40	5,41
Držiak		150/25200	1,93	2,32
Studnica	80x80/110	1/100	8,10	9,72
Sítka	2 mb	1/600	12,00	14,40
Tesnení do spojky	135	10	0,80	0,96
Tesnení do čielka	135	10	0,14	0,17

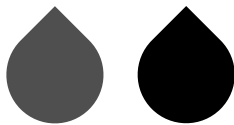

RAL 7016

RAL 9005

SYSTEM

135 / 80x80

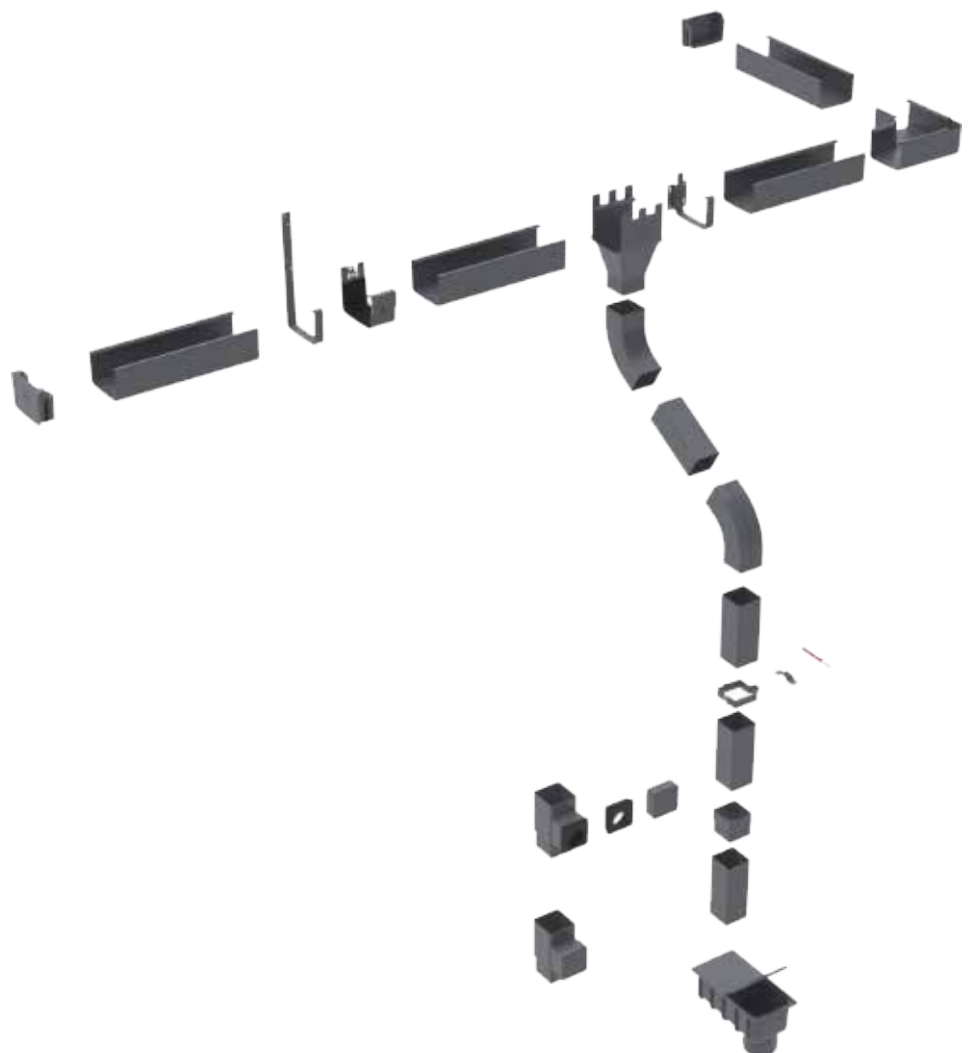
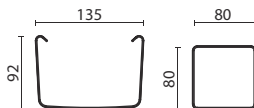



	Balenie ks	Cena/ks bez DPH	Cena /ks s DPH
Nastaviteľný hák krycej lišty			
Rozmer			
-	22	6,97	8,35
Spevnená krycia lišta			
205 x 2000	2	20,46	25,17
Spojka krycej lišty			
55 x 207	64	6,42	7,89
Čelo krycej lišty			
-	32	11,08	13,62
Vnútorý/ Vonkajší rohový diel krycej lišty			
-	15	10,77	13,24
Spojka zvodovej rúry s tesnením			
90,5 / 86,7	24	4,40	5,42
Podžľabový pás			
2000	1	11,37	13,98
Podhľadový pás			
2000	1	15,02	18,48
Izolácia zvodovej rúry			
200 x 200 x 1000	1	11,06	13,61
Pružné koleno			
90/110	18	12,75	15,68
Revízna šachta s poklopom			
250 x 250	1	17,23	21,19
Revízna šachta bez poklopu			
250 x 250	1	13,16	16,18
Poklop revíznej šachty			
250 x 250	150	4,07	5,01
Adaptér do hranatej rúry			
90/80 x 80	22	5,93	7,29



Plné podbitie farba

Rozmer	Balenie ks	Cena/ks bez DPH	Cena /ks s DPH
3000x305 (m ²)	18/21	9,78	12,03
0,91 m ² (ks)	1	8,90	10,95

Podhlady perforované farba

3000x305 (m ²)	18/21	9,78	12,03
0,91 m ² (ks)	1	8,90	10,95

Montážna lišta J farba

3000 (bm)	40/48	1,23	1,51
3000 (ks)	1	3,69	4,54

Montážna lišta H farba

3000 (bm)	22/28	2,89	3,55
3000 (ks)	1	8,66	10,65

Vonkajšia rohová lišta farba

3000 (bm)	12/45	4,14	5,09
3000 (ks)	1	12,43	15,29

Podhlady plné Polyester RAL drevedekor

3000x305 (m ²)	18/21	12,88	15,84
0,91 m ² (ks)	1	11,94	14,69

Podhlady perforované Polyester RAL drevedekor

3000x305 (m ²)	18/21	12,88	15,84
0,91 m ² (ks)	1	11,94	14,69

Montážna lišta J Polyester RAL drevedekor

3000 (bm)	40/48	1,68	2,06
3000 (ks)	1	5,03	6,18

Montážna lišta H Polyester RAL drevedekor

3000 (bm)	22/28	3,51	4,31
3000 (ks)	1	10,52	12,94

Vonkajšia rohová lišta Polyester RAL drevedekor

3000 (bm)	12/45	4,77	5,87
3000 (ks)	1	14,32	17,61





Strešné doplnky

 **BLACHOTRAPEZ®**

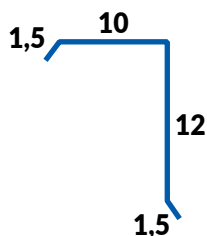

Záveterná lišta horná

Povrchová úprava	Hrúbka mm	Cena/ks bez DPH	Cena /ks s DPH
Aluzinok	0,50	6,96	8,55
Štandard RAL - lesk, Štandard MAT (AM), Wrinkle mat	0,50	10,60	13,04
Pladur® Relief IceCrystal, Superior HB	0,50	12,49	15,36
Pladur® Relief Textured Wood	0,50	13,80	16,97
Hliník Stucco/MAT	0,60	13,80	16,97

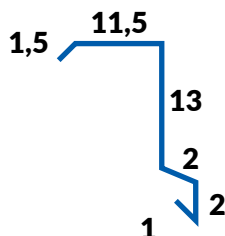

Záveterná lišta horná

Povrchová úprava	Hrúbka mm	Cena/ks bez DPH	Cena /ks s DPH
Aluzinok	0,50	8,62	10,61
Štandard RAL - lesk, Štandard MAT (AM), Wrinkle mat	0,50	13,15	16,17
Pladur® Relief IceCrystal, Superior HB	0,50	15,48	19,04
Pladur® Relief Textured Wood	0,50	17,11	21,04
Hliník Stucco/MAT	0,60	17,11	21,04

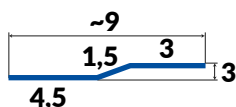

Spojovacia lišta - klik panel

Povrchová úprava	Hrúbka mm	Cena/ks bez DPH	Cena /ks s DPH
Aluzinok	0,50	2,50	3,08
Štandard RAL - lesk, Štandard MAT (AM), Wrinkle mat	0,50	3,82	4,70
Pladur® Relief IceCrystal, Superior HB	0,50	4,49	5,53
Pladur® Relief Textured Wood	0,50	4,97	6,11
Hliník Stucco/MAT	0,60	4,97	6,11

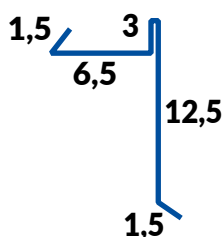

Záveterná lišta dolná

Povrchová úprava	Hrúbka mm	Cena/ks bez DPH	Cena /ks s DPH
Aluzinok	0,50	6,96	8,55
Štandard RAL - lesk, Štandard MAT (AM), Wrinkle mat	0,50	10,60	13,04
Pladur® Relief IceCrystal, Superior HB	0,50	12,49	15,36
Pladur® Relief Textured Wood	0,50	13,80	16,97
Hliník Stucco/MAT	0,60	13,80	16,97

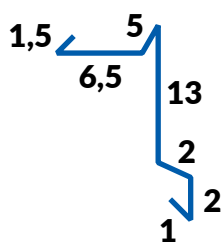

Záveterná lišta - Germania, Estima, Enigma, Talia, Diamant Plus

Povrchová úprava	Hrúbka mm	Cena/ks bez DPH	Cena /ks s DPH
Aluzinok	0,50	8,62	10,61
Štandard RAL - lesk, Štandard MAT (AM), Wrinkle mat	0,50	13,15	16,17
Pladur® Relief IceCrystal, Superior HB	0,50	15,48	19,04
Pladur® Relief Textured Wood	0,50	17,11	21,04
Hliník Stucco/MAT	0,60	17,11	21,04

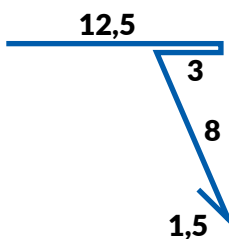

Štartovacia lišta - Retro Panel

Povrchová úprava	Hrúbka mm	Cena/ks bez DPH	Cena /ks s DPH
Aluzinok	0,50	6,96	8,55
Štandard RAL - lesk, Štandard MAT (AM), Wrinkle mat	0,50	10,60	13,04
Pladur® Relief IceCrystal, Superior HB	0,50	12,49	15,36
Pladur® Relief Textured Wood	0,50	13,80	16,97
Hliník Stucco/MAT	0,60	13,80	16,97

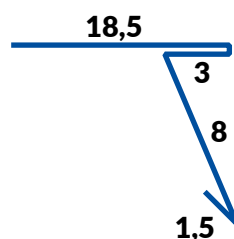

Štartovacia lišta - klik panel

Povrchová úprava	Hrúbka mm	Cena/ks bez DPH	Cena /ks s DPH
Aluzinok	0,50	8,62	10,61
Štandard RAL - lesk, Štandard MAT (AM), Wrinkle mat	0,50	13,15	16,17
Pladur® Relief IceCrystal, Superior HB	0,50	15,48	19,04
Pladur® Relief Textured Wood	0,50	17,11	21,04
Hliník Stucco/MAT	0,60	17,11	21,04

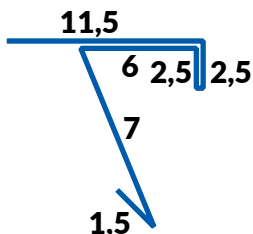

Štartovacia lišta - Jánošík, Modulová krytina

Povrchová úprava	Hrúbka mm	Cena/ks bez DPH	Cena /ks s DPH
Aluzinok	0,50	8,62	10,61
Štandard RAL - lesk, Štandard MAT (AM), Wrinkle mat	0,50	13,15	16,17
Pladur® Relief IceCrystal, Superior HB	0,50	15,48	19,04
Pladur® Relief Textured Wood	0,50	17,11	21,04
Hliník Stucco/MAT	0,60	17,11	21,04

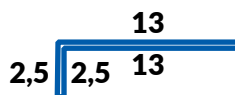

Štartovacia lišta

Povrchová úprava	Hrúbka mm	Cena/ks bez DPH	Cena /ks s DPH
Aluzinok	0,50	8,62	10,61
Štandard RAL - lesk, Štandard MAT (AM), Wrinkle mat	0,50	13,15	16,17
Pladur® Relief IceCrystal, Superior HB	0,50	15,48	19,04
Pladur® Relief Textured Wood	0,50	17,11	21,04
Hliník Stucco/MAT	0,60	17,11	21,04

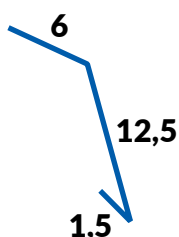

Nadodkvapný pás

Povrchová úprava	Hrúbka mm	Cena/ks bez DPH	Cena /ks s DPH
Aluzinok	0,50	5,56	6,84
Štandard RAL - lesk, Štandard MAT (AM), Wrinkle mat	0,50	8,48	10,43
Pladur® Relief IceCrystal, Superior HB	0,50	9,99	12,29
Pladur® Relief Textured Wood	0,50	11,04	13,58
Hliník Stucco/MAT	0,60	11,04	13,58



Podokapní pás

Povrchová úprava	Hrúbka mm	Cena/ks bez DPH	Cena /ks s DPH
Aluzinok	0,50	5,56	6,84
Štandard RAL - lesk, Štandard MAT (AM), Wrinkle mat	0,50	8,48	10,43
Pladur® Relief IceCrystal, Superior HB	0,50	9,99	12,29
Pladur® Relief Textured Wood	0,50	11,04	13,58
Hliník Stucco/MAT	0,60	11,04	13,58

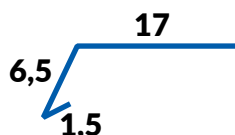

Pododkvapný pás

Povrchová úprava	Hrúbka mm	Cena/ks bez DPH	Cena /ks s DPH
Aluzinok	0,50	6,96	8,55
Štandard RAL - lesk, Štandard MAT (AM), Wrinkle mat	0,50	10,60	13,04
Pladur® Relief IceCrystal, Superior HB	0,50	12,49	15,36
Pladur® Relief Textured Wood	0,50	13,80	16,97
Hliník Stucco/MAT	0,60	13,80	16,97

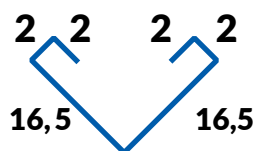

Úžľabie

Povrchová úprava	Hrúbka mm	Cena/ks bez DPH	Cena /ks s DPH
Aluzinok	0,50	11,41	14,03
Štandard RAL - lesk, Štandard MAT (AM), Wrinkle mat	0,50	17,39	21,39
Pladur® Relief IceCrystal, Superior HB	0,50	20,48	25,19
Pladur® Relief Textured Wood	0,50	22,63	27,83
Hliník Stucco/MAT	0,60	22,63	27,83

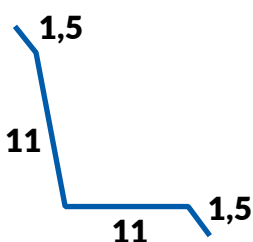

Lemovanie ku stene - spodné

Povrchová úprava	Hrúbka mm	Cena/ks bez DPH	Cena /ks s DPH
Aluzinok	0,50	6,96	8,55
Štandard RAL - lesk, Štandard MAT (AM), Wrinkle mat	0,50	10,60	13,04
Pladur® Relief IceCrystal, Superior HB	0,50	12,49	15,36
Pladur® Relief Textured Wood	0,50	13,80	16,97
Hliník Stucco/MAT	0,60	13,80	16,97

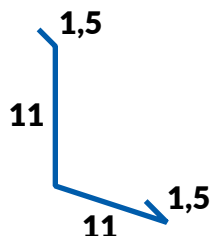

Lemovanie ku stene - spodné

Povrchová úprava	Hrúbka mm	Cena/ks bez DPH	Cena /ks s DPH
Aluzinok	0,50	6,96	8,55
Štandard RAL - lesk, Štandard MAT (AM), Wrinkle mat	0,50	10,60	13,04
Pladur® Relief IceCrystal, Superior HB	0,50	12,49	15,36
Pladur® Relief Textured Wood	0,50	13,80	16,97
Hliník Stucco/MAT	0,60	13,80	16,97

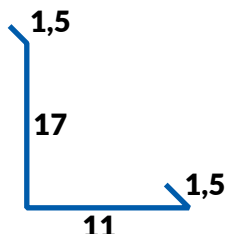

Lemovanie ku stene - spodné

Povrchová úprava	Hrúbka mm	Cena/ks bez DPH	Cena /ks s DPH
Aluzinok	0,50	8,62	10,61
Štandard RAL - lesk, Štandard MAT (AM), Wrinkle mat	0,50	13,15	16,17
Pladur® Relief IceCrystal, Superior HB	0,50	15,48	19,04
Pladur® Relief Textured Wood	0,50	17,11	21,04
Hliník Stucco/MAT	0,60	17,11	21,04

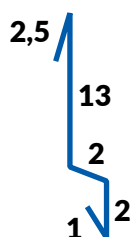

Záveterná lišta - Retro Panel

Povrchová úprava	Hrúbka mm	Cena/ks bez DPH	Cena /ks s DPH
Aluzinok	0,50	5,70	7,02
Štandard RAL - lesk, Štandard MAT (AM), Wrinkle mat	0,50	8,70	10,70
Pladur® Relief IceCrystal, Superior HB	0,50	10,24	12,59
Pladur® Relief Textured Wood	0,50	11,31	13,92
Hliník Stucco/MAT	0,60	11,31	13,92

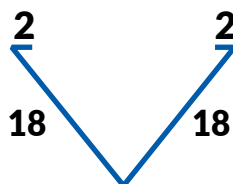

Úžľabie

Povrchová úprava	Hrúbka mm	Cena/ks bez DPH	Cena /ks s DPH
Aluzinok	0,50	11,13	13,69
Štandard RAL - lesk, Štandard MAT (AM), Wrinkle mat	0,50	16,97	20,87
Pladur® Relief IceCrystal, Superior HB	0,50	19,98	24,57
Pladur® Relief Textured Wood	0,50	22,07	27,15
Hliník Stucco/MAT	0,60	22,07	27,15

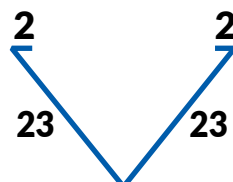

Úžľabie

Povrchová úprava	Hrúbka mm	Cena/ks bez DPH	Cena /ks s DPH
Aluzinok	0,50	13,91	17,11
Štandard RAL - lesk, Štandard MAT (AM), Wrinkle mat	0,50	21,21	26,09
Pladur® Relief IceCrystal, Superior HB	0,50	24,97	30,71
Pladur® Relief Textured Wood	0,50	27,59	33,94
Hliník Stucco/MAT	0,60	27,59	33,94

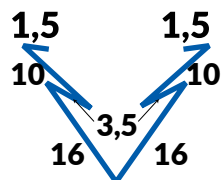

Úžľabie

Povrchová úprava	Hrúbka mm	Cena/ks bez DPH	Cena /ks s DPH
Aluzinok	0,50	17,25	21,22
Štandard RAL - lesk, Štandard MAT (AM), Wrinkle mat	0,50	26,30	32,35
Pladur® Relief IceCrystal, Superior HB	0,50	30,96	38,08
Pladur® Relief Textured Wood	0,50	34,21	42,08
Hliník Stucco/MAT	0,60	34,21	42,08

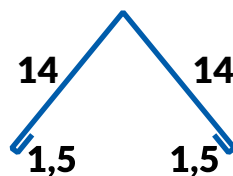

Hrebenáč - hladký

Povrchová úprava	Hrúbka mm	Cena/ks bez DPH	Cena /ks s DPH
Aluzinok	0,50	8,62	10,61
Štandard RAL - lesk, Štandard MAT (AM), Wrinkle mat	0,50	13,15	16,17
Pladur® Relief IceCrystal, Superior HB	0,50	15,48	19,04
Pladur® Relief Textured Wood	0,50	17,11	21,04
Hliník Stucco/MAT	0,60	17,11	21,04

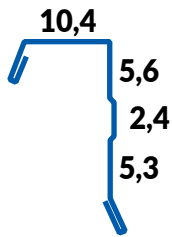

Záveterná lišta profilovaná

Povrchová úprava	Hrúbka mm	Cena/ks bez DPH	Cena /ks s DPH
Aluzinok	0,50	9,81	12,06
Štandard RAL - lesk, Štandard MAT (AM), Wrinkle mat	0,50	18,70	23,00
Pladur® Relief IceCrystal, Superior HB	0,50	23,72	29,17
Pladur® Relief Textured Wood	0,50	26,89	33,07
Hliník Stucco/MAT	0,60	26,89	33,07

Snehový zachytávač

Povrchová úprava	Hrúbka mm	Cena/ks bez DPH	Cena /ks s DPH
Aluzinok ZMGA (spevňujúci L profil)	0,70	2,73	3,36
Aluzinok	0,50	8,62	10,61
Štandard RAL - lesk, Štandard MAT (AM), Wrinkle mat	0,50	13,15	16,17
Pladur® Relief IceCrystal, Superior HB	0,50	15,48	19,04
Pladur® Relief Textured Wood	0,50	17,11	21,04
Hliník Stucco/MAT	0,60	17,11	21,04

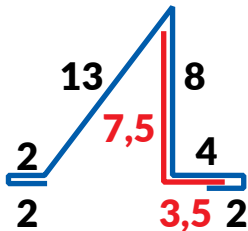

Profilovaná lišta Kuga Line

Povrchová úprava	Hrúbka mm	Cena/ks bez DPH	Cena /ks s DPH
Pladur® Wrinkle mat	0,50	18,56	22,83
Pladur® Wrinkle Mat Plus	0,50	23,76	29,23
Hliník Stucco/MAT	0,60	29,65	36,46

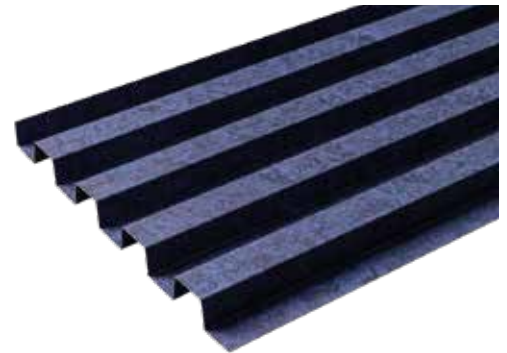
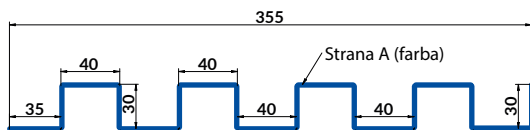

Fasádná doska - LAMEL

Povrchová úprava	Dĺžka m	Hrúbka mm	Záruka rokov	MJ bm/ks	Cena bez DPH	Cena s DPH
Polyester RAL drevodekor (na mieru)	1 - 6	0,50	10	m ²	41,94	51,59
Pladur® Wrinkle mat (na mieru)	1 - 6	0,50	45	m ²	36,13	44,44
Polyester RAL drevodekor (2 bm doska)	2	0,50	10	ks	24,84	30,56
Pladur® Wrinkle mat (2 bm doska)	2	0,50	45	ks	21,86	26,89
Polyester RAL drevodekor (3 bm doska)	3	0,50	10	ks	37,26	45,83
Pladur® Wrinkle mat (3 bm doska)	3	0,50	45	ks	32,79	40,33

Neštandardné lemovky

Povrchová úprava	Hrúbka mm	Cena/m ² bez DPH	Cena /m ² s DPH
Aluzinok	0,50	23,81	29,27
Polyester štandard RAL - lesk	0,50	29,19	35,91
Polyester štandard MAT (AM)	0,50	29,19	35,91
Pladur® Wrinkle mat	0,50	29,19	35,91
Pladur® Relief IceCrystal	0,50	37,71	46,38
Superior HB	0,50	37,71	46,38
Pladur® Relief Textured Wood	0,50	42,26	51,98
Pladur® Wrinkle Mat Plus	0,50	42,26	51,98
Polyester RAL drevodekor	0,50	42,26	51,98
Hliník Stucco/MAT	0,60	42,26	51,98



Škridl'ový hrebenáč

Povrchová úprava

	Hrúbka mm	Cena/ks bez DPH	Cena /ks s DPH
Polyester štandard RAL - lesk	0,50	14,60	17,96
Polyester štandard MAT Innova	0,50	14,60	17,96
Polyester štandard MAT (AM)	0,50	18,00	22,14
Pladur® Wrinkle mat	0,50	18,00	22,14
Pladur® Relief IceCrystal	0,50	22,63	27,84
Superior HB	0,50	22,63	27,84
Pladur® Wrinkle Mat Plus	0,50	22,73	27,96
Hliník Stucco/MAT	0,60	28,36	34,88



Trapezový hrebenáč

Povrchová úprava

	Hrúbka mm	Cena/ks bez DPH	Cena /ks s DPH
Aluzinok	0,50	10,26	12,63
Pozink	0,50	10,26	12,63
ZMGA	0,50	10,26	12,63
Polyester štandard RAL - lesk	0,50	12,88	15,84
Polyester štandard MAT (AM)	0,50	15,89	19,54
Pladur® Wrinkle mat	0,50	15,89	19,54
Pladur® Relief IceCrystal	0,50	20,51	25,22
Superior HB	0,50	20,51	25,22
Pladur® Wrinkle Mat Plus	0,50	20,89	25,69
Polyester RAL drevodekor	0,50	20,89	25,69
Hliník Stucco/MAT	0,60	26,17	32,20



Škridl'ový hrebenáč Premium

Povrchová úprava

	Hrúbka mm	Cena/ks bez DPH	Cena /ks s DPH
Polyester štandard MAT Innova	0,50	17,31	21,29
Polyester štandard MAT (AM)	0,50	19,45	23,92
Pladur® Wrinkle mat	0,50	19,45	23,92
Pladur® Relief IceCrystal	0,50	22,68	27,90
Superior HB	0,50	22,68	27,90
Pladur® Wrinkle Mat Plus	0,50	22,90	28,17
Polyester RAL drevodekor	0,50	22,90	28,17

Plechové tabule 1250x2000 mm

Povrchová úprava

	Hrúbka mm	Cena bez DPH	Cena s DPH
Aluzinok	0,50		
Aluzinok	0,70		
Polyester štandard RAL - lesk	0,50		
Polyester štandard RAL - lesk	0,70		
Polyester štandard RAL - lesk	0,75		
Polyester štandard MAT Innova	0,50		
Polyester štandard MAT (AM)	0,50		
Pladur® RAL Premium	0,50		
Pladur® Wrinkle mat	0,50		
Pladur® Relief IceCrystal	0,50		
Superior HB	0,50		
Pladur® Wrinkle Mat Plus	0,50		
Hliník Stucco/MAT	0,60		
Hliník MAT 7005 7016 8019 9005	0,70		
Pozink	0,50		
Polyester RAL drevodekor	0,50		
Polyester štandard RAL RDM 7016 8017	0,50		
Polyester štandard MAT MDM 7016 8017	0,50		
Perforovaný plech MAT (AM)	0,50		
Hliník MAT 7016 8019	0,70		

Zvitky 1250 mm

Hydrocontrol

Cena za meter bežný

Aluzinok	0,5
Aluzinok	0,7
Polyester štandard RAL - lesk	0,5
Polyester štandard RAL - lesk	0,7
Polyester štandard RAL - lesk	0,75
Polyester štandard MAT Innova	0,5
Polyester štandard MAT (AM)	0,5
Pladur® RAL Premium	0,5
Pladur® Wrinkle mat	0,5
Pladur® Relief IceCrystal	0,5
Pladur® Relief Textured Wood	0,5
Superior HB	0,5
Pladur® Wrinkle Mat Plus	0,5
Hliník Stucco/MAT	0,6
Hliník MAT 7005 7016 8019 9005	0,7
Pozink	0,5
Polyester RAL drevodekor	0,5
Polyester štandard RAL RDM 7016/8017	0,5
Polyester štandard MAT MDM 7016/8017	0,5
Hliník MAT 7016 8019 (šíre 1000)	0,7

Pri objednávke je potrebné vybrať BP na mieru
a v poznámkach do výroby zadať šírku pásov

Príplatok +3%

Príplatok +15% pri obj min ako 2,49 m.

BP 1250 mm strihaný

Min. šírka 156 mm**Min. dĺžka** 50 mb**Max. dĺžka** 800 mb**Max. dĺžka**

platí pre delenie na 2 pásy po 625mm

200 mb

platí pre delenie na 3 a viac pásov

(vrátane delenia na 2 pásy rôznej šírky)

Mobilné profilovanie

Materiál zakúpený v Blachotrapez do 150m ²	Cena m ²	2,50	3,08
Materiál zakúpený v Blachotrapez nad 150m ²	Cena m ²	1,30	1,60

Šírka pasov

625,00 mm - krycia šírka 545 mm

416,50 mm - krycia šírka 337 mm

312,50 mm - krycia šírka 232 mm

250,00 mm - krycia šírka 170 mm

STREŠNÉ DOPLNKY

Názov	Cena/bm bez DPH	Cena /bm s DPH
Čielko hrebenáča Premium	5,14	6,33
Čielko hrebenáča	3,16	3,89
Oblé ukončenie hrebenáča	15,80	19,44
Snehozábrany (všetky farby)	1,58	1,94
Podhrebenáčová lišta [239,270,315,340,460,529,554]	4,11	5,05
Podhrebenáčová lišta 2000 mm 18 (Jánošík,Tysenia); 23,36 Retro Panel*	17,38	21,38
Dachvent 120 3B	91,31	112,31
Dachvent 140 3B	111,62	137,30
Profilované tesnenie D/T – komplet	2,28	2,80
DR tesnenie typu páska, rozťažné 20x40/4,3(mb)/ks	18,58	22,86
DR tesnenie typu páska, rozťažné 20x50/3,3(mb)/ks	14,26	17,54
Opravný lak v spreji RAL 400 ml	10,95	13,46
Korekčný lak 15 ml fixka	5,98	7,35
Kaloty 35 Hlinik s EPDEM (100 ks)	59,92	73,70
Kaloty 40 Hlinik s EPDEM (100 ks)	63,47	78,07

*Podhrebenáčová lišta 2000 mm 18 (Jánošík); (23,36 Retro Panel); (26 Terrano)

Sojovací materiál

Názov	Počet ks	Cena/ks bez DPH	Cena /ks s DPH
 Farmársky vrut			
Farmárska skrutka polyester, PZ 4,8x22; 4,8x35	250	11,21	13,79
Farmárska skrutka polyester, PZ 4,8x55	200	15,91	19,57
Farmárska skrutka polyester, PZ 4,8x70	200	23,11	28,42
Farmárska skrutka polyester, PZ 4,8x100	100	15,08	18,55
Farmárska skrutka Hlinik 5,5x35	250	98,55	121,21
 Vrut Retro			
Samorezná skrutka 5,5x32/5mm	250	23,86	29,35
Samorezná skrutka 5,5x25/5mm	250	23,86	29,35
Samorezná skrutka 5,5x32/12mm	250	28,24	34,74
Samorezná skrutka 5,5x50/5mm	100	28,24	34,74
 Vrut TORX			
Samorezná skrutka PZ 4,2x19	500	11,93	14,68
Samorezná skrutka PZ 4,2x32	500	13,52	16,63
Skrutka do tenkej ocele a dreva 4,2x32* - Retro	500	11,93	14,67
Skrutka TORX 4,8x35 polyester, pozink	250	15,91	19,57
Skrutka TORX 4,8x19 polyester - veľkosklad	250	17,86	21,97
 Montážní koncovka			
Montážna koncovka s magnetom na TORX	1	11,64	14,32
Samorezná skrutka s polgulovou hlavou lamely	1000	66,93	82,33
Skrutka dištančná (TX) 60x120 mm	100	20,01	24,61
Skrutka dištančná (TX) 60x145 mm	100	24,99	30,73
Skrutka dištančná (TX) 60 x 160 mm	100	28,95	35,61
 Vrut s polokulatou hlavou			

Lepiace pásky

Názov	Cena/ks bez DPH	Cena /ks s DPH
UNISAN - jednostranná univerzálna páska na kov,drevo,plast, 60mm x 25m, 10ks/bal.	11,79	14,50
UNISAN - jednostranná univerzálna páska na kov,drevo,plast, 100mm x 25bm (50/50) , 6ks/bal.	22,55	27,74
Blachotrapez Compri Falz 10mm x 2 mm x 12,5 m (falcované krytiny)	4,20	5,17
Blachotrapez Butyl - páska, 15mm x 25m	6,25	7,69
Blachotrapez Complex tesnenie typu páska, rozťažná 20x50/4,3(mb)	8,82	10,84
Blachotrapez UNO- jednostranná páska, 50mm x 25m	9,23	11,35
Blachotrapez DUO- obojstranná páska, 20mm x 25m	5,95	7,31
Blachotrapez PUR 40x30 - Jednostranná páska určená na zabezpečenie tesnosti v stavebníctve	6,36	7,82
Blachotrapez PUR 60x30 - Jednostranná páska určená na zabezpečenie tesnosti v stavebníctve	8,71	10,72
Blachotrapez TOPBAND - páska na lepenie a opravu paropriepustných fólií, 50mm x 25m, farba sivá	9,74	11,98
Blachotrapez Jednostranná metalická páska ALUFIX 75mm x 50 mb	2,99	3,68
Blachotrapez FLEX 3D- samolepiaca komínová páska, 300mmx5m farba tehlová, hnedá, seda, čierna	26,14	32,15
Blachotrapez FLEXBIT- bituménová páska, 100mmx10m farba tehlová, hnedá, seda	12,30	15,13
Blachotrapez FLEXBIT- bituménová páska, 150mmx10m farba tehlová, hnedá, seda	16,61	20,42
Blachotrapez FLEXBIT- bituménová páska, 300mmx10m farba tehlová, hnedá, seda	29,83	36,69

Odvetrávanie

Názov	Cena/ks bez DPH	Cena /ks s DPH
Blachotrapez VRABČIAK (hrebeň proti hlodavcom), 60mm x 1m farba tehlová, hnedá, čierna	0,45	0,55
Blachotrapez ODVETRÁVACIA MRIEŽKA- ochranná mriežka, 80mm x 5m farba tehla, hnedý, čierny	2,77	3,40
Blachotrapez ODVETRÁVACIA MRIEŽKA- ochranná mriežka, 100mm x 5m farba tehla, hnedý, čierny	3,28	4,03
Blachotrapez ODVETRÁVACIA MRIEŽKA Hliník- ochranná mriežka, 100mm x 25m farba hnedý, sivá	68,16	83,84
Blachotrapez ROLL STANDARD- vetračí pás pod hrebeň 310mmx5m farba tehlová, hnedá, čierna, visnia	10,25	12,61

Strešné prestupy

Názov	Cena/ks bez DPH	Cena /ks s DPH
Solaros Metal - solárna prechodka	50,00	61,50
Sattos - anténna prechodka	36,00	44,28
Ventos Metal - podstavec+ventilačný komín	36,00	44,28
Ventos Flat - podstavec+ventilačný komín	36,00	44,28
Ventosa Roto - podstavec+ventilačný komín - RAL (3011, 7016, 8004, 8017, 8019, 9005)	110,00	135,30
Bitu UNI (Trapez) EPDM - podstavec+ventilačný komín, priemer fi 150 8004, 8017, 8019, 7021, 9005	49,20	60,52
Blachotrapez FLEXOS X - elastická napájacia rúra, ø 150/125/120/100/80mm, dĺžka 0,60 cm	10,25	12,61
Blachotrapez FLEX X - elastická napájacia rúra, ø 150mm/150mm, dĺžka 6 m	24,76	30,46
Manzeta MFR 1 ø 12,7 - 101,6 mm, podst. 208 x 208 mm	39,28	48,31
Manzeta MFR 2 ø 101,6 - 235 mm, podst. 362 x 362 mm	69,70	85,73
Manzeta MFR 3 ø 235 - 412,8 mm, podst. 546 x 546 mm	146,80	180,56
Manzeta MF 1 ø 6,4 - 70 mm, podst. 114 x 114 mm	19,93	24,51
Manzeta MF 2 ø 6,4 - 70 mm, podst. 114 x 114 mm	22,94	28,22
Manzeta MF 3 ø 6,3 - 146 mm, podst. 203 x 203 mm	27,43	33,74
Manzeta MF 4 ø 70 - 178,8 mm, podst. 254 x 254 mm	32,90	40,47
Manzeta MF 5 ø 102 - 209,5 mm, podst. 280 x 280 mm	38,75	47,66
Manzeta MF 6 ø 121 - 254 mm, podst. 305 x 305 mm	43,48	53,48
Manzeta MF 7 ø 140 - 292 mm, podst. 356 x 356 mm	59,88	73,65
Manzeta MF 8 ø 171,4 - 342 mm, podst. 432 x 432 mm	79,87	98,24



Solaros Metal



Sattos



Ventos Metal



Ventos Flat



Ventosa Roto



Bitu UNI

Podstrešné folie

Názov	Role m ²	Cena/ks bez DPH	Cena /ks s DPH
DACHVENT 140 3B paropriepustná membrána 1,6x50 = 80 m2 s paskou	80	84,05	103,38
Blachotrapez EXTRA 140- paropriepustná fólia 1,5x50m=75m2	75	71,75	88,25
Blachotrapez EXTRA 140- paropriepustná fólia 1,5x50m=75m2 s paskou	75	82,00	100,86
Blachotrapez EXTRA 140- paropriepustná fólia 1,5x25m=37,5m2	37,5	38,95	47,91
Blachotrapez EXTRA 180- paropriepustná fólia 1,5x50m=75m2 s paskou	75	102,50	126,08
Blachotrapez BITUMI 450 g/m2 - paropriepustná fólia 1,0 x 30m=30 m2 0,5g/m2/24h Novinka s paskou	30	102,50	126,08
Blachotrapez EXTRA 200- paropriepustná fólia 1,5x50m=75m2 - štvorvrstvá s paskou	75	141,45	173,98
MPRoof 170 g/m2 TPU + PES 1,5x50	75	233,70	287,45
Fólia 200 NG 3B na plné debnenie 1,5x30 - Retro, Click System	45	112,75	138,68
Blachotrapez EXTRA 450 METAL - paropriepustná fólia (na debnenie)	36	190,65	234,50
Paroizolačná fólia- Blachotrapez ALUPET 110g/m2 Novinka		59,45	73,12
Paroizolačná fólia- Blachotrapez ALUPET 130g/m2 Novinka		74,83	92,03

Ostatné doplnky

Názov	Cena/ks bez DPH	Cena /ks s DPH
Blachotrapez DRŽIAK G- držiak hrebeňovej laty, 40x210mm	0,64	0,78
ZK-0n Haftra posuvna vys 25 mm , 30 mm	0,27	0,33
ZK-1 Haftra stala vys 25 mm, 30 mm	0,18	0,23
Nity 4,0x 10 pozink, 3009, 6020, 7024, 8004, 8017, 8019, 9005 100ks/bal	5,00	6,15
Koncovka parapetu 2ks L-P 3005, 3009, 3011, 5010, 7016, 8004, 8017, 8019, 9005, 9006, 9010	3,12	3,83
Magnetický držiak bitov Blachotrapez 8 mm	2,67	3,28
Presvetľovacie profily hr. 1,00 s UV ochranou T18+; T35+ dl. 3 m, 4m (cena za m ²)	22,00	27,06

Snehozábrany

Názov	Cena/ks bez DPH	Cena /ks s DPH
Blachotrapez TUBE - protisnehová rúra 2m	15,68	19,29
Blachotrapez FIX TUBE METAL FLAT 1/FLAT 2 - držiak 2 protisnehových rúr na falcovanú krytinu/Retro, Trapez	11,48	14,12
Blachotrapez CLIP TUBE - spojka protisnehovej rúry,	1,23	1,51
Blachotrapez END TUBE - ukončenie protisnehovej rúry	2,67	3,28
Blachotrapez AQ.Tyčová snehozábrana na falcovanú krytinu, 2 tyče, 1,5 m*	59,40	73,06
Blachotrapez AQ.Tyčová snehozábrana na falcovanú krytinu, 2 tyče, 3 m*	118,80	146,12
Blachotrapez AQ.Tyčová snehozábrana na plechovú škridlu, trapéz, 2 tyče, 1,5 m*	46,80	57,56
Blachotrapez AQ.Tyčová snehozábrana na plechovú škridlu, trapéz, 2 tyče, 3 m*	93,60	115,13
Blachotrapez AQ.Tyčová snehozábrana na Jánošíka, Thunderd, Bolt, Mistral, Blizzard, 2 tyče, 1,5 m*	53,10	65,31
Blachotrapez AQ.Tyčová snehozábrana na Jánošíka, Thunderd, Bolt, Mistral, Blizzard, 2 tyče, 3 m*	106,20	130,63

Farebná škála produktov TUBE, FIX TUBE, END TUBE RAL (3009, 7016, 8004, 8017, 8019, 9005).

Farebná škála Tyčových snehozábran RAL (3009, 7016, 8004, 8017, 8019, 9005).

* 1,5 m (2 tyče, skrutky, EPDM tesnenia, držiaky 2ks) | 3 m (2 tyče, skrutky, EPDM tesnenia, držiaky 4ks)

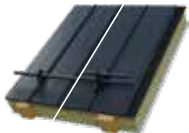

FIX tube Metal Flat 1 | Flat 2



AQ Tyčová snehozábrana falc



AQ Tyčová snehozábrana škridla | trapéz



AQ Tyčová snehozábrana Jánošík | BTR

Strešná komunikácia

Názov	Cena/ks bez DPH	Cena /ks s DPH
Blachotrapez AQ. Kominárska lávka na plechovú škridlu, trapéz 0,8 m, sada: skrutky, EPDM tesnenia, držiaky 2ks	72,00	88,56
Blachotrapez AQ. Kominárska lávka na plechovú škridlu, trapéz 1,2 m, sada: skrutky, EPDM tesnenia, držiaky 2 ks	86,40	106,27
Blachotrapez AQ. Kominárska lávka na Retro panel, 0,8 m, sada: skrutky, EPDM tesnenia, držiaky 2 ks	77,40	95,20
Blachotrapez AQ. Kominárska lávka na Retro panel, 1,2 m, sada: skrutky, EPDM tesnenia, držiaky 2 ks	90,00	110,70
CWL Kominársky stupeň stesnenie a skrutkami	23,78	29,25
CWL Strešný rebřík na plechovú škridlu, 1,5 m, sada: skrutky, EPDM tesnenia, držiaky	299,30	368,14
CWL Strešný rebřík na plechovú škridlu, 2,4 m, sada: skrutky, EPDM tesnenia, držiaky	359,14	441,74
CWL Strešný rebřík na Retro panel/falcovanú krytinu, 1,5 m, sada: skrutky, EPDM tesnenia, držiaky	295,20	363,10
CWL Strešný rebřík na Retro panel/falcovanú krytinu, 2,4 m, sada: skrutky, EPDM tesnenia, držiaky	354,65	436,22

Farebná škála produktov AQ RAL (Ral 3009, 7016, 8004, 8017, 8019, 9005).



AQ Lávka škridla | trapéz



AQ Lávka falc



CWL Žebřík



CWL Stupeň

Kotvičný bod

Názov	Cena/ks bez DPH	Cena /ks s DPH
Kotviaci bod - na trapéz (nehrdzavejúca ocel) 180-420 mm	310,25	381,60
Kotviaci bod - na trapéz (nehrdzavejúca ocel) 250-370 mm	229,60	282,41
Kotviaci bod - na plechovú škridlu (nehrdzavejúca ocel)	264,45	325,27
Kotviaci bod - na falcovanú krytinu (nehrdzavejúca ocel)	190,65	234,50



trapéz



škridla



falc

Držiaky solárnych kolektorov

Názov	Cena/ks bez DPH	Cena /ks s DPH
CWL Držiak solárnych kolektorov na falcovanú krytinu, 5 ks/sada	54,73	67,31
CWL Držiak solárnych kolektorov na plechovú škridlu, 5 ks/sada	110,92	136,43



CWL držiak na falc. krytinu

Stavebná chémia

Názov	Jednotka ml/m	Cena/ks bez DPH	Cena /ks s DPH
SIKAFLEX 11 FC PURFORM šedý	300	10,05	12,36
SIKAFLEX 11 FC PURFORM čierny	300	10,05	12,36
SIKAFLEX 11 FC PURFORM hnedý	300	10,05	12,36
SIKAFLEX 11 FC PURFORM čer. drevo	300	10,05	12,36
SIKAFLEX 11 FC PURFORM biely	300	10,05	12,36
SIKAFLEX 11 FC PURFORM terakota	300	10,05	12,36
SIKAFLEX CONSTRUCTION biely	600	11,41	14,03
pSIKAFLEX CONSTRUCTION šedý	600	11,41	14,03
SIKAFLEX CRYSTALCLEAR	290	9,14	11,24
SIKA CLEANING WIPES 100 (50ks)	-	12,35	15,19
SIKABLACK SEAL	300	4,64	5,71
SIKA Anchorfix	300	8,86	10,90
SIKAGARD 715 W	2000	29,49	36,27
pištol Manual Gun 310 ML	-	20,00	24,60
SIKASIL - C transparentný	300	4,93	6,06
SikaHyflex-600 transparent	600	18,08	22,24
SikaBoom-187 C49	750	7,34	9,03
SikaBoom-587 C49	750	7,84	9,64
SikaBoom-583 C49	750	6,85	8,42
SikaBoom-582 C49	750	8,58	10,55

Klince, klincovačka a príslušenstvo

Názov	Jednotka ks	Cena/ks bez DPH	Cena /ks s DPH
Klince ND34 3,1 X 90 GR /prstencové klince TYP 34° - odporúčané výrobcom Milwaukee	2000	39,57	48,67
Klince v páse ND 34 28 X 65 ZR ring klince TYP 34°	3000	64,40	79,21
Klince v páse NR22 28 X 65 ZR ring klince TYP 20 - 22°	3000	74,45	91,57
Klince NP16 3,1 X 35 ZR ring. klince	3000	39,57	48,67
Klince ND34 2,9 X 75 GR /prstencové - Klince TYP 34°	3000	64,39	79,20
Plyn 40G 80ML	1	15,06	18,52
Klince Haften 2,8 X 25 ZR /prstencové	2000	86,10	105,90
Klince Haften 2,8 X 25 NR /prstencové	3600	172,20	211,81
Plyn Hafter 20G 30ML	1	16,40	20,17
Plynová klincovačka NH22/35 HAFTER	1	1 276,29	1 569,83
IPS 80 Skrutka do izolačných materiálov RAL 7016, 8004, 8017, 9005, 9010	50	34,85	42,87
Plastová dištančná podložka Dw 02	50	1,87	2,30
Plastová dištančná podložka Dw 03	50	1,96	2,41
Plastová dištančná podložka Dw 04	50	2,20	2,70
Plastová dištančná podložka Dw 05	50	2,49	3,06
Plastová dištančná podložka Dw 08	50	3,54	4,35
Plastová dištančná podložka Dw 10	50	4,09	5,02
Plastová dištančná podložka Dw 15	50	5,22	6,42
Tesárske skrutky WKCP-8x100	50	7,50	9,23
Tesárske skrutky WKCP-8x120	50	8,50	10,46
Tesárske skrutky WKCP-8x180	50	14,50	17,84
Tesárske skrutky WKCP-8x200	50	19,50	23,99
Tesárske skrutky WKCP-8x240	50	23,50	28,91
Tesárske skrutky WKCP-8x280	50	30,00	36,90
Tesárske skrutky WKCP-8x300	50	32,50	39,98



Plotové systémy

 **BLACHOTRAPEZ**®

PANEL MODERN (500 - 3000mm)

Názov		Cena/bm bez DPH	Cena/bm s DPH
Plotový Panel Modern 100 mm		9,98	12,27
Plotový Panel Modern 160 mm		11,48	14,12
Plotový Panel Modern 220 mm		13,00	15,99

Grafit 7016, Čierna 9005, Zlatý Dub 3D, Orech, Rustikálny Dub, Dub Prírodný, Sapphire

Montážna súprava - Panel Modern

		Cena/ks bez DPH	Cena/ks s DPH
Sada na svojpomocnú montáž	1250 mm	102,56	126,15
Sada na svojpomocnú montáž	1500 mm	115,38	141,92
Sada na svojpomocnú montáž	2000 mm	128,21	157,69
Sada na svojpomocnú montáž	2500 mm	146,15	179,77

Posuvné brány s motorom

Posuvná brána výplň 100 160 220mm L/P	1,5x4 m	2 051,28	2 523,08
---	---------	----------	----------

Dostupné farebné prevedenia: grafit 7016, čierna 9005, orech, zlatý dub 3D, čierna + orech, čierna + zlatý dub 3D

Dvojkřídlové brány s pohonom

Brána dvojkřídlová výplň 100 160 220 mm	1,5x4 m	1 871,79	2 302,31
---	---------	----------	----------

Dostupné farebné prevedenia: grafit 7016, čierna 9005, orech, zlatý dub 3D, čierna + orech, čierna + zlatý dub 3D

Bránky

Bránka výplň 100 160 220 mm	1,5x1 m	435,90	536,15
---------------------------------	---------	--------	--------

Dostupné farebné prevedenia: grafit 7016, čierna 9005, orech, zlatý dub 3D, čierna + orech, čierna + zlatý dub 3D

Plotový dielec

Plotový dielec 100 160 220 mm STANDARD / PREMIUM	1,25x2,5 m	346,15	425,77
--	------------	--------	--------

Dostupné farebné prevedenia: grafit 7016, čierna 9005, orech, zlatý dub 3D, čierna + orech, čierna + zlatý dub 3D

Stĺp štandardný RAL 7016, 9005

Stĺp do betónu 80x80 mm	2 m	51,28	63,08
Stĺp do betónu 100x100 mm	2 m	56,41	69,38

Neštandardné rozmery (A) Šírka 3,5 - 6 m

Názov		Cena/m ² bez DPH	Cena/m ² s DPH
Posuvná brána - výška, šírka, smer otvárania, farba, pohon		384,62	473,08
Dvojkřídlová brána - výška, šírka, smer otvárania, farba, pohon		333,33	410,00
Bránka - výška, šírka, smer otvárania, farba		307,69	378,46
Plotový dielec - výška, šírka, smer otvárania, farba		128,21	157,69

Neštandardné rozmery (B)

Názov		Cena/ks bez DPH	Cena/ks s DPH
Posuvná brána - plocha do 5m ²		1 897,44	2 333,85
Brána dvojkřídlová - plocha do 5m ²		1 538,46	1 892,31
Bránka - plocha do 1,5 m ²		512,82	630,77
Plotový dielec - plocha do 2 m ²		269,23	331,15

Stĺpy neštandardné RAL 7016, 9005

		Cena/bm bez DPH	Cena/bm s DPH
Stĺp 80x80x2,0mm (1-3 m)		25,64	31,54
Stĺp 100x100x2,0mm (1-3 m)		28,21	34,69
Stĺp na skrutky 80x80x2,0mm (1,3-2 m)		87,18	107,23
Stĺp na skrutky 100x100x2,0mm (1,3-2 m)		97,44	119,85

Montážne sady

Názov	Cena/ks bez DPH	Cena /ks s DPH
Sada na montáž panelov k oceľovým stĺpikom - STANDARD, STANDARD PLUS	12,82	15,77
Sada na montáž panelov k betónovým stĺpikom - STANDARD, STANDARD PLUS	20,51	25,23
Sada na montáž panelov k oceľovým stĺpikom - PREMIUM	4,10	5,05
Sada na montáž panelov k betónovým stĺpikom - PREMIUM	14,10	17,35
Úchytka - uholník 90 stupňov do panela - PREMIUM RAL7016/RAL9005	28,21	34,69
Doplňky k pohonu	230,77	283,85
Pohon Somfy Elixo 500 RTS	666,67	820,00
Pohon Somfy Elixo 800 RTS	717,95	883,08
Pohon Somfy Ixengo 3S RTS	948,72	1 166,92
Dialkový ovládač do pohonov SOMFY	28,21	34,69
Elektrozámok do brány - guľa/kľučka	69,23	85,15
Madlo STANDARD zvarané RAL7016/RAL9005	64,10	78,85
Madlo PREMIUM zvarané RAL7016/RAL9005	79,49	97,77
Madlo STANDARD/PREMIUM nerez	128,21	157,69
Poštová schránka - Grafit 7016 / Čierna 9005 (600x1500)	769,23	946,15
Tyč 28x28x1,2 s vyrazenými otvormi na skrutky (farba: zinok, grafit 7016, čierna 9005; dĺžka: 2000 mm)	8,46	10,41
Vnútrotný c-profil (do výšky 160 cm)	12,82	15,77

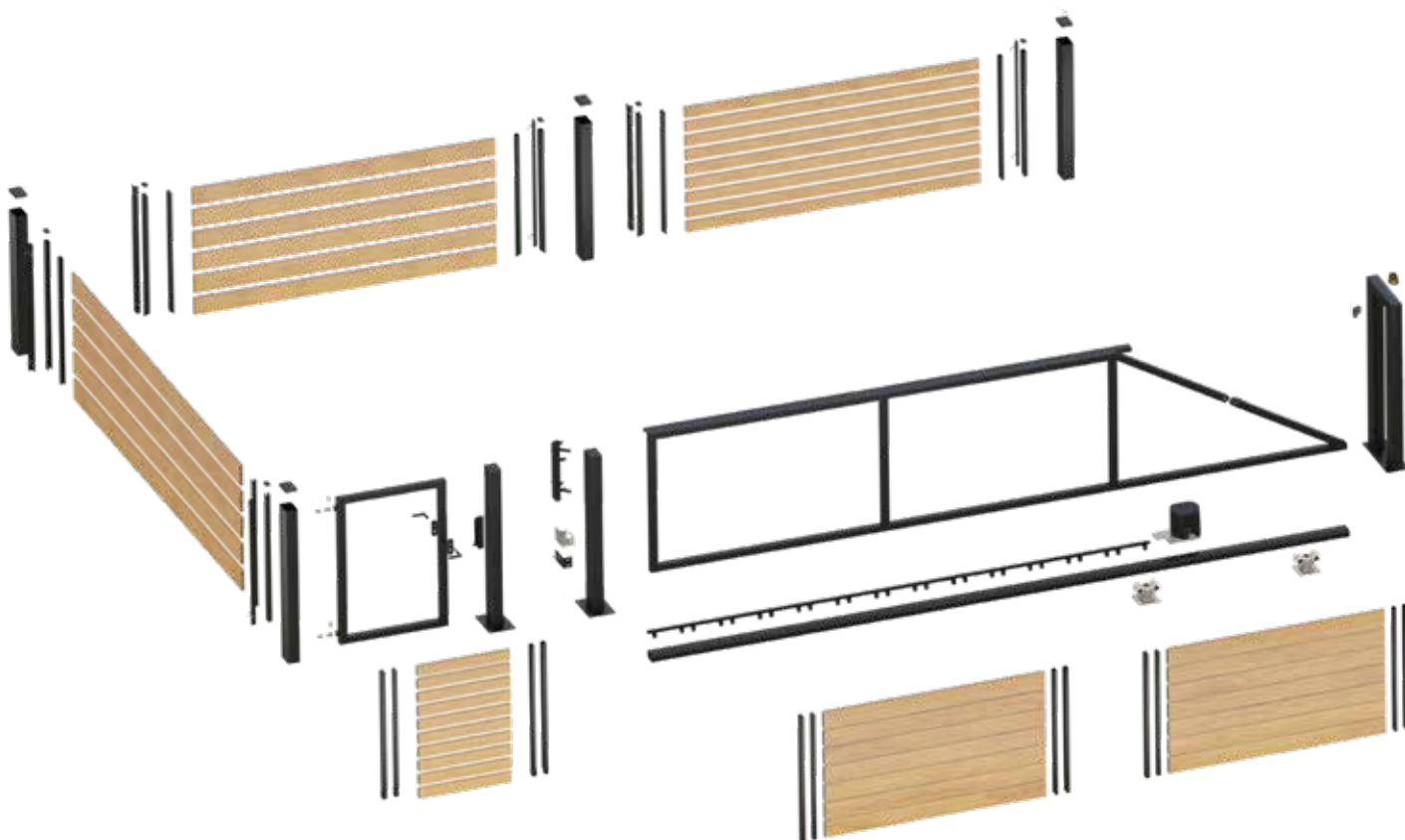



Plotová lamela

Názov	Cena/mb bez DPH	Cena /mb s DPH
Plotová lamela úzka RAL RDM 8017; 7016	2,67	3,28
Plotová lamela úzka Farba MAT MDM 8017; 7016	2,87	3,53
Plotová lamela úzka Polyester RAL drevodekor - Zlatý dub Zlatý dub 3D Orech	2,46	3,03
Plotová lamela široká* Pladur® Relief Textured Wood	3,73	4,59
Plotová lamela široká* Polyester štandard RAL - lesk	2,48	3,05
Plotová lamela široká* Polyester štandard mat (AM)	2,56	3,15
Plotová lamela široká* Pladur® Wrinkle mat Superior HB	2,82	3,47
Plotová lamela široká* Pladur® Relief IceCrystal	2,89	3,56
Plotová lamela široká* Pladur® Wrinkle Mat Plus	3,22	3,96
Plotová lamela široká* Polyester RAL drevodekor - Zlatý dub Zlatý dub 3D Orech	3,05	3,76
Plotová lamela široká* RDM Rustikálny Dub	4,10	5,05

* možnosť výroby s rovnou alebo oblou hranou

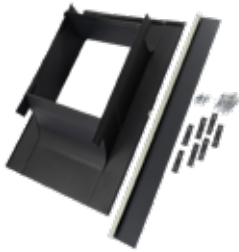

Lemovanie komína OKS, OKP, OKC, OKF - štandard

Typ	Cena/ks bez DPH	Cena/ks s DPH
Pozink prírodný / farbený	117,00	143,91
Hliniik prírodný / farbený	134,55	165,50
Meď	269,10	330,99
Titanzinok	211,77	260,48

Štandardné rozmery - Vonkajší rozmer tvárnice (cm) - 32 x 32; 36 x 36; 40 x 40; 48 x 48

Lemovanie komína OKS, OKP, OKC, OKF - neštandard

Veľkosť*	PZ prírodný/farbený Cena bez DPH Cena s DPH	AL prírodný/farbený Cena bez DPH Cena s DPH	Meď Cena bez DPH Cena s DPH	Titanzinok Cena bez DPH Cena s DPH
Do 100	128,70	146,25	280,80	223,47
	158,30	179,89	345,38	274,87
Od 101 do 125	128,70	152,10	332,28	246,87
	158,30	187,08	408,70	303,65
Od 126 do 150	128,70	154,44	347,49	265,59
	158,30	189,96	427,41	326,68
Od 151 do 175	134,55	161,46	368,55	280,80
	165,50	198,60	453,32	345,38
Od 176 do 200	136,89	169,65	415,35	311,22
	168,37	208,67	510,88	382,80
Nad 200	143,91	183,69	485,55	354,51
	177,01	225,94	597,23	436,05

* SÚČET STRÁN A+B (cm) TELESA KOMÍNA

Príklad výpočtu pre neštandardný rozmer: Ak rozmer telesa komína je: A/38cm, B/54cm, potom súčet strán telesa komína je 38+54=92cm, potom cena za lemovanie komína o rozmere 38x54 je do 100cm, podľa tabuľky pre neštandardné rozmery telesa komína.

Kazetové oplechovanie komína HOK - štandard



Veľkosť*	PZ prírodný/farbený Cena bez DPH Cena s DPH	AL prírodný/farbený Cena bez DPH Cena s DPH	Meď Cena bez DPH Cena s DPH	Titanzinok Cena bez DPH Cena s DPH
32 x 32	149,76	188,37	477,36	354,51
	184,20	231,70	587,15	436,05
36 x 36	152,10	194,22	500,76	370,89
	187,08	238,89	615,93	456,19
40 x 40	154,44	198,90	524,16	386,10
	189,96	244,65	644,72	474,90
48 x 48	156,78	204,75	547,56	402,48
	192,84	251,84	673,50	495,05

Kazetové oplechovanie komína HOK - neštandard

Veľkosť*	PZ prírodný/farbený Cena bez DPH Cena s DPH	AL prírodný/farbený Cena bez DPH Cena s DPH	Meď Cena bez DPH Cena s DPH	Titanzinok Cena bez DPH Cena s DPH
Do 100	161,46	211,77	582,66	425,88
	198,60	260,48	716,67	523,83
Od 101 do 125	167,31	224,64	641,16	464,49
	205,79	276,31	788,63	571,32
Od 126 do 150	157,00	244,53	728,91	522,99
	193,11	300,77	896,56	643,28
Od 151 do 175	177,84	256,23	785,07	560,43
	218,74	315,16	965,64	689,33
Od 176 do 200	190,71	269,10	845,91	601,38
	234,57	330,99	1 040,47	739,70
Nad 200	196,56	274,95	851,76	607,23
	241,77	338,19	1 047,66	746,89

* SÚČET STRÁN A+B (cm) TELESA KOMÍNA

Príklad výpočtu pre neštandardný rozmer: Ak rozmer telesa komína je: A/38cm, B/54cm, potom súčet strán telesa komína je 38+54=92cm, potom cena za kazetové oplechovanie komína o rozmere 38x54 je do 100cm, podľa tabuľky pre neštandardné rozmery telesa komína.

Cena je platná pre výšku komína (rozmer L1) do 150 cm.

Lemovanie komína OKS, OKP, OKC, OKF - neštandard

Nadstavba pre výšku komína (rozmer L1) nad 150 cm

Veľkosť*	PZ prírodný/farbený Cena bez DPH Cena s DPH	AL prírodný/farbený Cena bez DPH Cena s DPH	Meď Cena bez DPH Cena s DPH	Titánzinok Cena bez DPH Cena s DPH
Do 100	17,55	26,91	99,45	69,03
	21,59	33,10	122,32	84,91
Od 101 do 125	18,72	29,25	109,98	74,88
	23,03	35,98	135,28	92,10
Od 126 do 150	19,89	32,76	127,53	86,58
	24,46	40,29	156,86	106,49
Od 151 do 175	22,23	35,10	138,06	94,77
	27,34	43,17	169,81	116,57
Od 176 do 200	23,40	38,61	150,93	102,96
	28,78	47,49	185,64	126,64
Nad 200	25,74	40,95	162,63	114,66
	31,66	50,37	200,03	141,03

* SÚČET STRÁN A+B (cm) TELESA KOMÍNA

Príklad výpočtu pre nadstavbu: Ak rozmer telesa komína je: A/38cm, B/54cm a výška komína L1=175 cm, je súčet strán telesa komína do 100 cm a výška komína nad 150 cm. Potom cena pre materiál Pz/Pz RAL je 129,- EUR bez DPH + 20,- EUR bez DPH = 149,- EUR bez DPH.

Cena nadstavby každých 25 cm navyše.

Komínová krycia doska KDK, KDH - štandard



Veľkosť**	PZ prírodný/farbený Cena bez DPH Cena s DPH	AL prírodný/farbený Cena bez DPH Cena s DPH	Meď Cena bez DPH Cena s DPH	Titánzinok Cena bez DPH Cena s DPH
50 x 50	53,82	53,82	88,92	57,33
	66,20	66,20	109,37	70,52
55 x 55	53,82	53,82	92,43	58,50
	66,20	66,20	113,69	71,96
65 x 65	56,16	56,16	99,45	60,84
	69,08	69,08	122,32	74,83

Komínová krycia doska KDK, KDH - neštandard

Veľkosť*	PZ prírodný/farbený Cena bez DPH Cena s DPH	AL prírodný/farbený Cena bez DPH Cena s DPH	Meď Cena bez DPH Cena s DPH	Titánzinok Cena bez DPH Cena s DPH
Do 100	65,52	65,52	100,62	69,03
	80,59	80,59	123,76	84,91
Od 101 do 150	69,03	62,00	118,17	74,88
	84,91	76,26	145,35	92,10
Od 151 do 200	72,54	67,86	135,72	80,73
	89,22	83,47	166,94	99,30
Od 201 do 250	83,07	83,07	173,16	93,60
	102,18	102,18	212,99	115,13
Od 251 do 300	91,26	91,26	208,26	104,13
	112,25	112,25	256,16	128,08
Nad 300	108,81	108,81	280,80	128,70
	133,84	133,84	345,38	158,30

SÚČET STRÁN A+B (cm) TELESA KOMÍNA

Príklad výpočtu pre neštandardný rozmer: Ak rozmer krycej dosky je: A/63cm, B/65cm, potom súčet strán krycej dosky je 63+65=128cm, potom cena za kryciu dosku o rozmere 63x65 je od 101 do 150cm, podľa tabuľky pre neštandardné rozmery krycej dosky.

Cena je platná pre jednoprieduchové komínové krycie dosky. Cena za každý ďalší prieduch je 12,-EUR s DPH (10,-EUR bez DPH).

Komínová strieška „Napoleon“ KSN



Veľkosť	PZ prírodný/farbený Cena bez DPH Cena s DPH	AL prírodný/farbený Cena bez DPH Cena s DPH	Meď Cena bez DPH Cena s DPH	Titánzinok Cena bez DPH Cena s DPH
44x44	- -	- -	129,87 159,74	93,60 115,13
44x75	- -	- -	140,40 172,69	97,11 119,45
44x100	- -	- -	140,40 172,69	97,11 119,45
44x125	- -	- -	186,03 228,82	99,45 122,32
54x54	- -	- -	136,89 168,37	95,94 118,01
54x75	- -	- -	149,76 184,20	99,45 122,32
54x100	- -	- -	149,76 184,20	99,45 122,32
54x125	- -	- -	186,03 228,82	104,13 128,08
64x64	- -	- -	143,91 177,01	95,94 118,01
64x75	- -	- -	152,10 187,08	100,62 123,76
64x100	- -	- -	159,12 195,72	101,79 125,20
64x125	- -	- -	186,03 228,82	107,64 132,40
74x74	- -	- -	163,80 201,47	101,79 125,20
74x100	- -	- -	180,18 221,62	107,64 132,40
74x125	- -	- -	197,73 243,21	112,32 138,15
84x84	- -	- -	189,54 233,13	108,81 133,84
94x94	- -	- -	196,56 241,77	112,32 138,15

Cena zahŕňa nemontované stavacie nožičky a nerezový spojovací materiál, vrátane kotvenia. Cena za montáž stavacích nožičiek na mieru, v požadovanom rozstupe je 12,- EUR s DPH/set (10,-EUR bez DPH/set).

Príklad výpočtu pre neštandardný rozmer: Ak rozmer komínovej striešky je: A/64cm, B/80cm, potom najbližšia vyššia dĺžka B je 100 cm, potom cena za komínovú striešku o rozmere A/64xB/80 je rovnaká ako pre rozmer 64x100, podľa tabuľky pre štandardné rozmery komínovej striešky „Napoleon“.

Oplechovanie atiky montážnym systémom OAMS



Veľkosť	PZ prírodný/farbený Cena bez DPH Cena s DPH	AL prírodný/farbený Cena bez DPH Cena s DPH	AL Prefa Cena bez DPH Cena s DPH	Titánzinok Cena bez DPH Cena s DPH
31,5	21,41 26,34	25,97 31,95	25,97 31,95	- -
41,5	22,35 27,49	27,14 33,39	32,88 40,44	- -
51	23,93 29,43	28,31 34,83	40,42 49,72	- -
62,5	25,10 30,87	29,72 36,55	42,65 52,46	- -
75	25,39 31,23	29,72 36,55	45,05 55,41	- -
85	25,39 31,23	31,36 38,57	46,98 57,78	- -
100	26,44 32,52	32,53 40,01	49,78 61,23	- -

Uvedené ceny sú za bežný meter

Rohovník



Veľkosť	PZ prírodný/farbený Cena bez DPH Cena s DPH	AL prírodný/farbený Cena bez DPH Cena s DPH	AL Prefa Cena bez DPH Cena s DPH	Titánzinok Cena bez DPH Cena s DPH
31,5	32,18 39,58	34,16 42,02	36,62 45,04	- -
41,5	32,99 40,58	23,99 29,50	38,84 47,78	- -
51	33,93 41,73	37,21 45,76	40,95 50,37	- -
62,5	34,87 42,89	38,96 47,92	43,52 53,53	- -
75	36,04 44,32	40,95 50,37	46,45 57,13	- -
85	36,97 45,48	7,25 8,92	48,67 59,87	- -
100	38,26 47,06	44,69 54,97	52,18 64,18	- -

Uvedené ceny sú za kus.

Všeobecné príplatky

Názov	Cena bez DPH	Cena s DPH
Ochranná fólia	0,43	0,53
Ochranná fólia Terrano	0,67	0,82
Malé objednávky do 30 m ²	0,96	1,18
Dripstop	1,40	1,72

Palety pod strešnú krytinu | Terrano (vratné)

2 m; T1	26,00	32,00
3 m; 4m; 5m; 6m; T2; T5	65,00	80,00

Paleta pod odkvapový systém KROP

Zvody, zľaby drevena	40,00	50,00
Zvody, zľaby kovova	325,00	390,00

Paleta pod Gard

Gard drevena	110,00	135,00
Gard kovova	620,00	760,00

Doprava

Vykladka HDS (max dĺžka objednávky 9 m)	32,52	40,00
Doprava krytiny nad 50 m ² alebo 1100 euro / K zakazníkovi	18,00	22,14
Doprava Velkoskad do 400 euro / K zakazníkovi	40,65	50,00
Doprava Velkoskad nad 401 euro / K zakazníkovi	18,00	22,14
Doprava krytiny nad 50 m ² alebo 1100 euro ; Velkoskad nad 401 euro - sklad zmlovneho partnera, osobny odber	0,00	0,00

Požičovňa náradia - vratná záloha

Klincovačka	200,00	240,00
Gilotína BTR na rezanie plechu	200,00	240,00
Ohýbačka BTR Systém	200,00	240,00
Nízkootáčková píla na rezanie plechu	200,00	240,00

Svet Klampiara ^{BLACHOTRAPEZ®}

SO ŠIROKOU PONUKOU POTRIEB PRE KLAMPIAROV



www.svetklampiara.sk

Vernostný program • Široký sortiment • Top značky

GROUP  **BLACHOTRAPEZ**



027 44 Tvrdošín
ul.Vojtaššákova 604



T.: +421 43 53 92 096



velkoobchod@blachotrapez.sk
www.blachotrapez.sk



IČO: 36423416
DIČ: SK2021879541